

NO	QTY	PART NO	DESCRIPTION	SEAL KIT
1	1	21510003	NUT, JAM, HEX, M14-1.50	
2	3	23350086	SPRING, COMPRESSION	X
3	3	23650010	BALL, TUNGSTEN-CARBIDE, 6mm	X
4	2	39051080	O-RING, (10mm X 1)	X
5	1	39051084	O-RING, (50mm X 2)	X
6	2	39051088	O-RING, (8mm X 3)	X
7	1	39053045	SEAL, WIPER, SNAP IN, WED, 28, 94A, AU	X
8	1	39056005	SEAL, STEP, ROD, 28	X
9	1	39056024	SEAL, CAP, PISTON, 50, 90A, AU GRPHT FLD	X
10	2	43068006	PLUG, PORT, HOLLOW HEX, G1/4	
11	1	81400134	PLUNGER, SC, 7MPa, 50B, LH	
12	1	81400154	CAP, LC/SC, 7MPa, 50B	
13	2	81400201	PLUG, MANIFOLD, 7MPa, M10	
14	3	81400203	PIN, STOP, BALL, METRIC, 6mm BALL	X
N/A	N/A	L6014500	KIT, SEAL, SC, 7MPa, 50B	NOTED

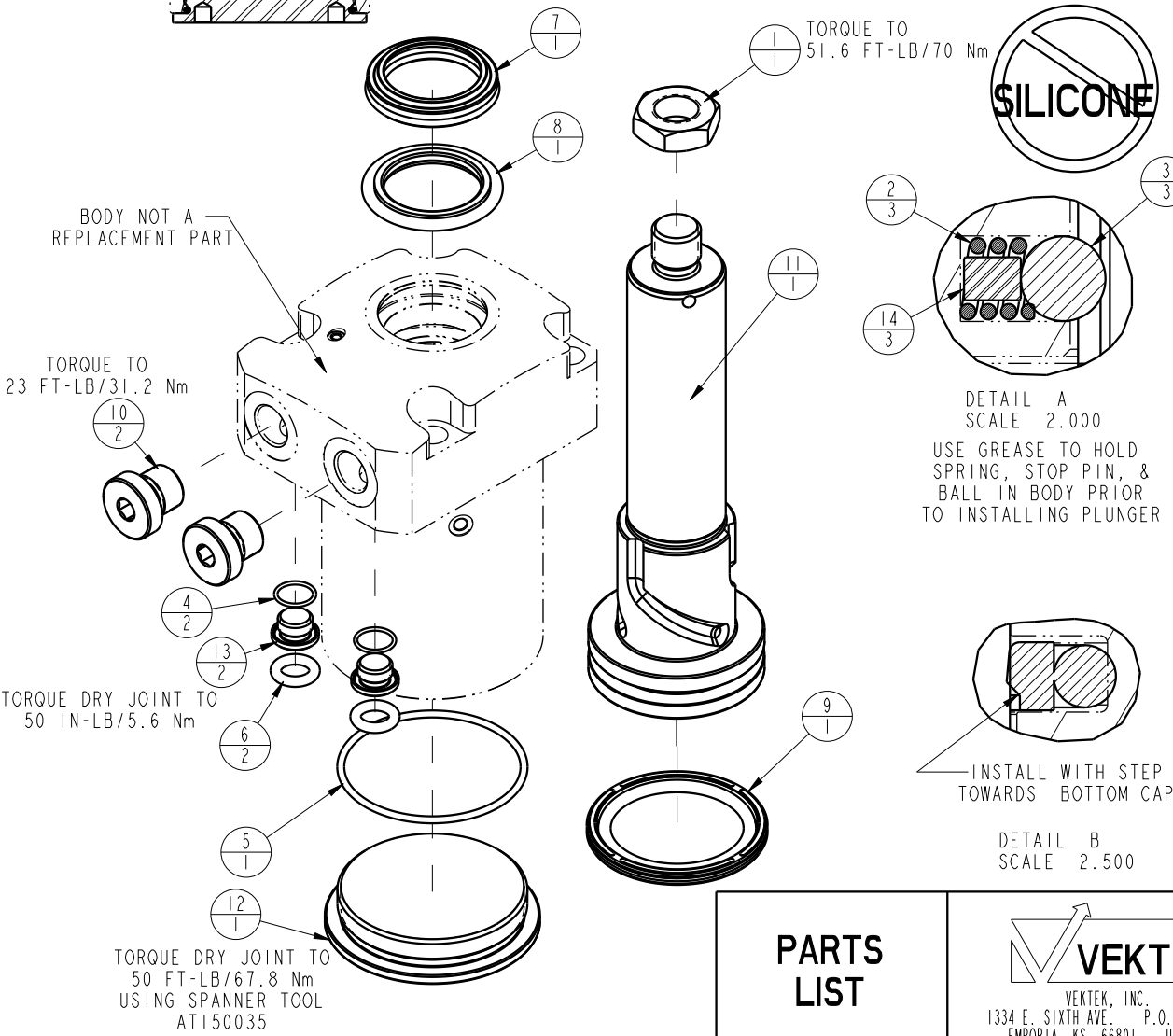

<b>PARTS LIST</b>		
	VEKTEK, INC. 1334 E. SIXTH AVE. P.O. BOX 625 EMPORIA, KS. 66801 U.S.A.	
ASSEMBLIES AFFECTED	PARTS LIST, ASSY, SC, TF, 7MPa, 50B, LH	
L140500L	*****	
SIZE A	LPL1406	REV B

B	3273	RELEASE	JDW	08/15/18
REV	IN ACCORDANCE WITH ECN	EFFECTIVE DATE	REVISED BY	DATE
DRW BY: QMITCHELL	<b>DRAWING STATUS: Released</b>			
DATE: 7-17-13	PRODUCTION APPROVED FOR RELEASED STATUS ONLY			