

NO	QTY	PART NO	DESCRIPTION	STD SEAL KIT	FKM SEAL KIT	SPRING KIT
1	1	23050010	WASHER	X	X	X
2	1	23350127	SPRING, COMPRESSION			X
3	1	39010012	SEAL, BEVEL, 5/16 X 3/32 X 1/2	X	39V10012	
4	1	39010030	GASKET, COPPER	X	X	X
5	1	82110504	PISTON, CYL, CM, 980, .50 STRK, THD			
6	1	39T55009	GASKET, (.451 x .100 x .080)	X	X	X
7	1	39V10029	WIPER, PRESS-IN, (1/4)	X	X	
N/A	N/A	60210105	KIT, SEAL,	NOTED	N/A	N/A
N/A	N/A	6V210105	KIT, SEAL, FKM,	N/A	NOTED	N/A
N/A	N/A	61210105	KIT, SPRING,	N/A	N/A	NOTED

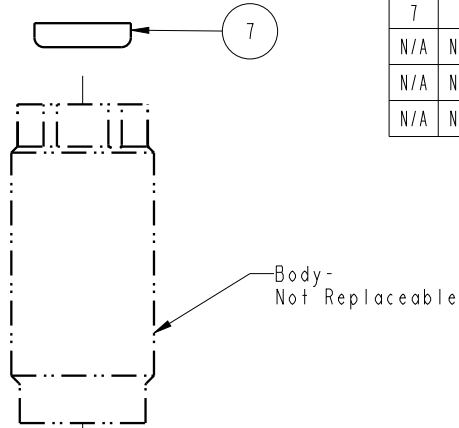

See IS-2100 for machining and installation instructions.

Lubricate all seals with clean hydraulic oil prior to assembly.
DO NOT USE SILICONE BASED LUBRICANTS

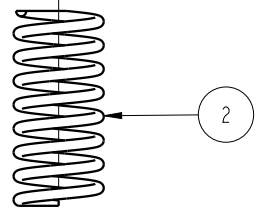

INSTALLATION TORQUE:
 -Metal Gasket = 40 ft-lb
 -Composite Gasket = 20 ft-lb
 *Cylinders may need to be re-torqued after a break-in period of 3 weeks or 2,500 cycles for both gasket styles

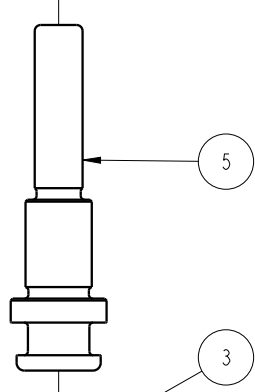

Both metal and composite gaskets are supplied. Use only one gasket. The metal gasket is recommended when the cavity seal surface has every smooth finish and is flat and perpendicular to the minor diameter. The metal gasket must be torqued to a higher value, which is more resilient to machining vibrations providing long term sealing. The composite gasket is recommended when the cavity seal surface has a rough surface finish or is not flat.

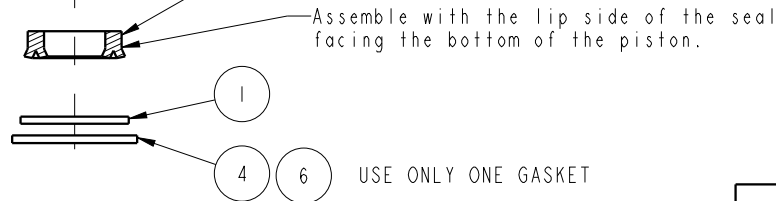

Assemble with the lip side of the seal facing the bottom of the piston.

USE ONLY ONE GASKET

PARTS LIST	 VEKTEK, INC. 1334 E. SIXTH AVE. P.O. BOX 625 EMPORIA, KS. 66801 U.S.A.	
	ASSEMBLIES AFFECTED	PARTS LIST, ASSY, CYL, CM, 980, .50 STRK, SA, THD
21-0105-06	SIZE A	PL2190
21-0105-06F	REV B	FORM FEG035_PL_ASIZE, REV. B

B	3140	RELEASE	BCD	11/9/16
REV	IN ACCORDANCE WITH ECN	EFFECTIVE DATE	REVISED BY	DATE
DRW BY:	MAJ	DRAWING STATUS: Released PRODUCTION APPROVED FOR RELEASED STATUS ONLY		
DATE:	4/1/16			

SHEET 1 OF 1

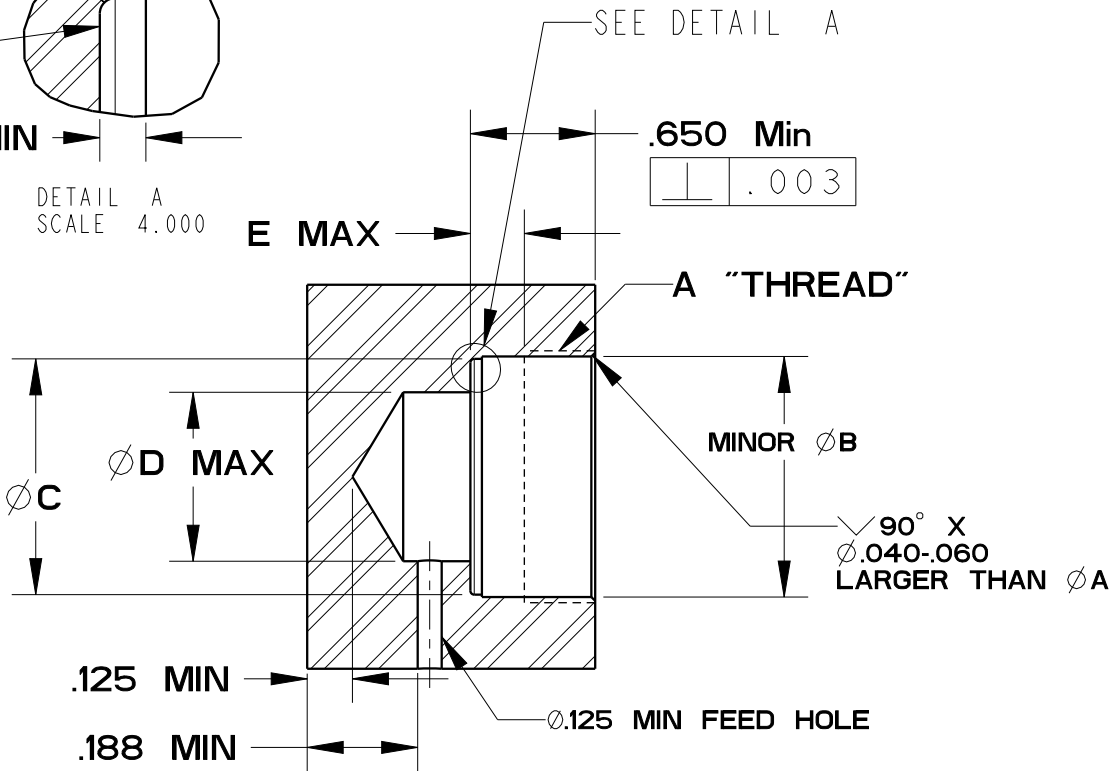
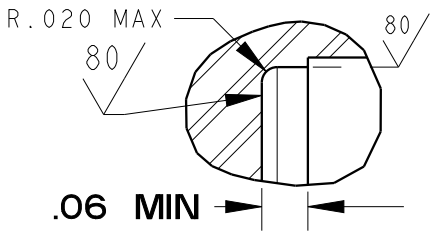

Tighten cylinders with a six point socket only !

Model No.	A	Metal Gasket Torque	Composite Gasket Torque	ØB	ØC	D	E
21-0102-00	3/8-24 UNF-2B	10 ft lb	NA	.335±.003	.325±.005	.13	.100
21-0104-02	5/8-18 UNF-2B	30 ft lb	15 ft lb	.572±.003	.545±.005	.31	.156
21-0105-03	3/4-16 UNF-2B	40 ft lb	20 ft lb	.690±.003	.662±.005	.38	.156
21-0105-04	3/4-16 UNF-2B	40 ft lb	20 ft lb	.690±.003	.662±.005	.38	.156
21-0105-05	3/4-16 UNF-2B	40 ft lb	20 ft lb	.690±.003	.662±.005	.38	.156
21-0105-06	3/4-16 UNF-2B	40 ft lb	20 ft lb	.690±.003	.662±.005	.38	.156
21-0108-04	1 1/16-16 UN-2B	50 ft lb	25 ft lb	1.002±.003	.923±.005	.63	.281
21-0108-05	1 1/16-16 UN-2B	50 ft lb	25 ft lb	1.002±.003	.923±.005	.63	.281
21-0108-08	1 1/16-16 UN-2B	50 ft lb	25 ft lb	1.002±.003	.923±.005	.63	.281
21-0110-04	1 5/16-16 UN-2B	NA	35 ft lb	1.253±.003	1.228±.005	.88	.281

*Cylinders may need to be re-torqued after a break-in period of 3 weeks or 2,500 cycles for both gasket styles.

Instruction Sheet



VEKTEK, INC.
1334 E. SIXTH AVE. P.O. BOX 625
EMPORIA, KS. 66801 U.S.A.

Model number -See Chart-

Cavity Dimensions

Cartridge Mounted Cylinders

SIZE A **IS-2100** REV G

FORM FEG041-IS-ASIZE, REV. B

G	3041	RELEASE	BCD	11/9/16
REV	IN ACCORDANCE WITH ECN	EFFECTIVE DATE	REVISED BY	DATE
DRW BY:	VANDALSEM			
DATE:	04-13-93			
DRAWING STATUS: Released PRODUCTION APPROVED FOR RELEASED STATUS ONLY				