

## 10 Technical Data

Vektek Electronic Pressure Switch	
Measuring element	Piezoresistive sensor
Measuring ranges	0 - 6000 psig, absolute: 0 - 150 psia
Display	4-digit 14-segment LED red display. Digit height .35 inches (9 mm). Display rate: 20/s
Transistor switching outputs PNP	Switching function: Normally open / normally closed, standard /window mode and diagnosis. Switching output: PNP. Adjustment range for switching point and hysteresis: 0% to 125% f. s. Switching frequency: Max. 100 Hz. Load: Max. 500 mA, short-circuit-proof. Delay: 0.0 s to 9.9 s adjustable. Status display(s): LED(s) red
Temperature range	Media: -13°F to 212°F (-25°C to +100°C) Electronics: 14°F to 158°F (-10°C to +70°C) Storage: -22°F to 176°F (-30°C to +80°C)
Process connection	7/16-20 (SAE 4)
Protection system <sup>2)</sup> /class	III
Electrical connection	Plug M12 x 1, 4-pin / 5-pin
Power supply	15 to 32 V DC, reversed polarity protected (SELV, PELV), Class 2
Approvals	cULus <sup>1)</sup>
For further technical data and options please refer to the data sheets	

- 1) Conditions of use: 60°C max. ambient, power supply max. 28 V DC  
 2) The stated ingress protection only applies when plugged in using mating connectors that have the appropriate ingress protection.

### Operating and display elements/Dimensions Dimensions (example) in mm (inch)

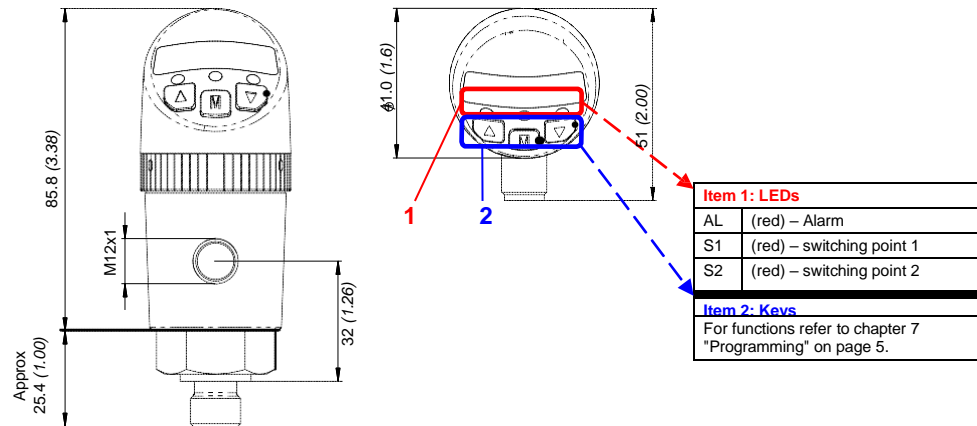

## Operating Instructions Vektek Electronic Pressure Switch



1	Intended Applications.....	2
2	Safety Instructions.....	2
3	Standards.....	3
4	Warranty/Guarantee.....	3
5	Installation.....	3
6	Commissioning/Operation.....	4
7	Programming.....	5-10
8	Maintenance/Cleaning.....	11
9	Decommissioning.....	11
10	Technical Data.....	12



P/N.: 70-7400-74  
 Index F, 19.08.2016  
 Software version: 1.2 or higher



Specifications are subject to changes without notice!

VEKTEK LLC  
 1334 E. 6<sup>th</sup> Ave  
 Emporia, Ks 66801  
 USA  
 Phone: 913-365-1045 (sales)  
 Fax: 816-364-0471 (sales)  
 620-342-7637 (technical service)  
 Email: [sales@vektek.com](mailto:sales@vektek.com)  
 Website: [www.vektek.com](http://www.vektek.com)

IS		7075	
REV.	B	EFF. DATE	03/02/17
ECN NO.		5121	
BY / DATE:		KR	07/21/23
APPR. / DATE:		GY	03/01/17
REV APPR. / DATE:		BCD	11/29/23

## 1 Intended Applications

The dual pressure switch monitors system pressures and has up to two switching outputs and one analog output.

### DANGER

The switch may only be used in the specified fields of application.  
The temperature ranges must be within the permissible limits. Do not exceed rated pressure and electrical load values.  
Observe also the applicable national and local safety instructions for assembly, commissioning and operation of the switch.  
The switch is not designed to be used as the only safety device in pressurized systems according to "Pressure Equipment Directive 97/23/EC (PED)".

## 2 Safety Instructions

The safety instructions are intended to protect the user from dangerous situations and/or prevent material damage.

In the operating instructions the seriousness of the potential risk is designated by the following signal words:

### DANGER

Refers to imminent danger to users.  
Nonobservance may result in fatal injuries.

### WARNING

Refers to a recognizable danger.  
Nonobservance may result in fatal injuries, and destroy the equipment or plant parts.

### CAUTION

Refers to a danger.  
Nonobservance may result in light injuries and material damage to the switch and/or to the plant.

### IMPORTANT

Refers to important information essential to the user.

### Disposal

The switch must be disposed of correctly in accordance with the national or local regulations for electric/electronic equipment.  
The switch must not be disposed of with the household trash!

## 3 Standards

The standards applied during development, manufacture and configuration are listed in the CE conformity and manufacturer's declaration.

## 4 Warranty/Guarantee

Our scope of delivery and services is governed by the legal warranties and warranty periods.

### Terms of guarantee

We guaranty for function and material of the dual pressure switch under normal operating and maintenance conditions in accordance with the statutory provisions.

### Loss of guarantee

The agreed guarantee period will expire in case of:

- incorrect use,
- incorrect installation or
- incorrect handling or operation contrary to the provisions of these operating instructions.

No liability is assumed for any damage resulting therefrom, or any consequential damage.

## 5 Installation

### CAUTION

Jolts and heavy vibrations must be avoided during transport. Even if the switch casing remains undamaged, inside parts may be damaged and cause malfunctions.

The pressure switch may only be installed and electrically connected by instructed staff.

### DANGER

The switch may only be installed in systems where the maximum pressure  $P_{max}$  is not exceeded (see type label).

Only install the switch when deenergized (electrically and hydraulically/pneumatically).

Mount the pressure switch from the bottom to the fitting using a wrench SW 27 and tighten it to a torque of 45 Nm.

### IMPORTANT

In the pressure inlet a damping screw made of brass is mounted. This screw can be removed if required, e.g. in case of soiled medium or material incompatibility, using a slotted screw driver (max. width 3 mm).

The pressure switch is less resistant to pressure peaks when the damping screw has been removed.

Electrical connection is to be carried out dependent on the type of switch (see name label) according to the chart below. Improper connections may cause malfunctions or incorrect switch outputs and damage to the unit.

**Electrical connection**

Plug M 12x1 4/5/8-pin	Model with 2 switch point and 1 analog output
1	+Ub
2	Signal
3	0V
4	SP1
5	SP2

**Plug**

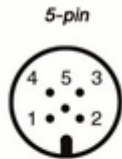

**6 Commissioning/Operation**

**The pressure switch may only be commissioned and operated by authorized staff.**

	<b>CAUTION</b>
Do not put the switch into operation when the switch itself or the connection cable is damaged.	

	<b>WARNING</b>
Be aware of the fact that in case of operation with higher temperatures the casing surface may become very hot!	

After having been switched on the switch runs through a self-test. If the software recognizes an error during the self-test or during operation, this is signalled in the display by "Err" and the corresponding message, refer to Error list on page 7. The red LEDs S1 and S2 signal the activity of the two switching points.

Operation is menu-driven via three keys: ▲, ▼ and M













	<b>CAUTION</b>
Do not use any pointed, hard objects for making entries. The keys may be damaged by pointed, hard objects.	











For information about the factory settings for the parameters and how to change them please refer to the next chapter 7 "Programming".

**7 Programming**

Navigation function	Symbol (keys)
Menu descending	▼
Menu ascending	▲
Horizontal movement in menu, select menu item	M
Parameter change ascending	▲
Parameter change descending	▼
Accept parameter change and return to current menu item	M
Return to measured value display	Press ▲ + ▼ simultaneously

## 7.1 Parameters



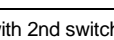



Parameter	14-segment display	Description
SP1/SP2*		Hysteresis function: Switching point of solid state contact
FH1/FH2*		Window function: Window High solid state contact
rP1/rP2*		Hysteresis function: Hysteresis of solid state contact
FL1/FL2*		Window function: Window Low solid state contact
EF		Extended programming functions
rES		Reset parameters to factory settings
dS1/dS2*		Switching time delay – the set contact rating must be permanently exceeded to trigger a switching function
dr1/dr2*		Switching time delay – the contact rating must be permanently lower than the set contact rating to trigger a switching function
Ou1/Ou2*		Switching function of solid state contact HNO = Hysteresis function, NO contact HNC = Hysteresis function, NC contact FNO = Window function, NO contact FNC = Window function, NC contact DIA = Diagnostic function, NO contact (only Ou2)
uni		Select unit: bar, PSI, MPa If the measuring range is outside the display range, unit selection is impossible. The parameter "uni" is not displayed.
OuA**		Analog output I = 4... 20 mA U = 0... 10 V I.INV = 20... 4 mA U.INV = 10... V
ASP**		Analog start value

Parameter	14-segment display	Description
AEP**		Analog end value
dPA**		Damping of analog output
ErS.A**		Error signal of analog output Values: < 3.6 or > 22 or Off
Hi		Saved value of highest pressure measured
Lo		Saved value of lowest pressure measured
COF		Offset correction (max. 10 % of measuring range)
ddis		Damping display
Fdis		Rotate display through 180°
udiS		Unit indication
Firm		Firmware version
Lock		Locking feature

\* only models with 2nd switching contact

\*\* only models with analog output

### Error list

Parameter	14-segment display	Description
sens		Sensor defect
SC1		Short circuit, solid state contact 1
SC2		Short circuit, solid state contact 2
AOut		Open output, short circuit
OL		Sensor limit positive
UL		Sensor limit negative
KEY		Internal defect

## 7.2 Menu Structure

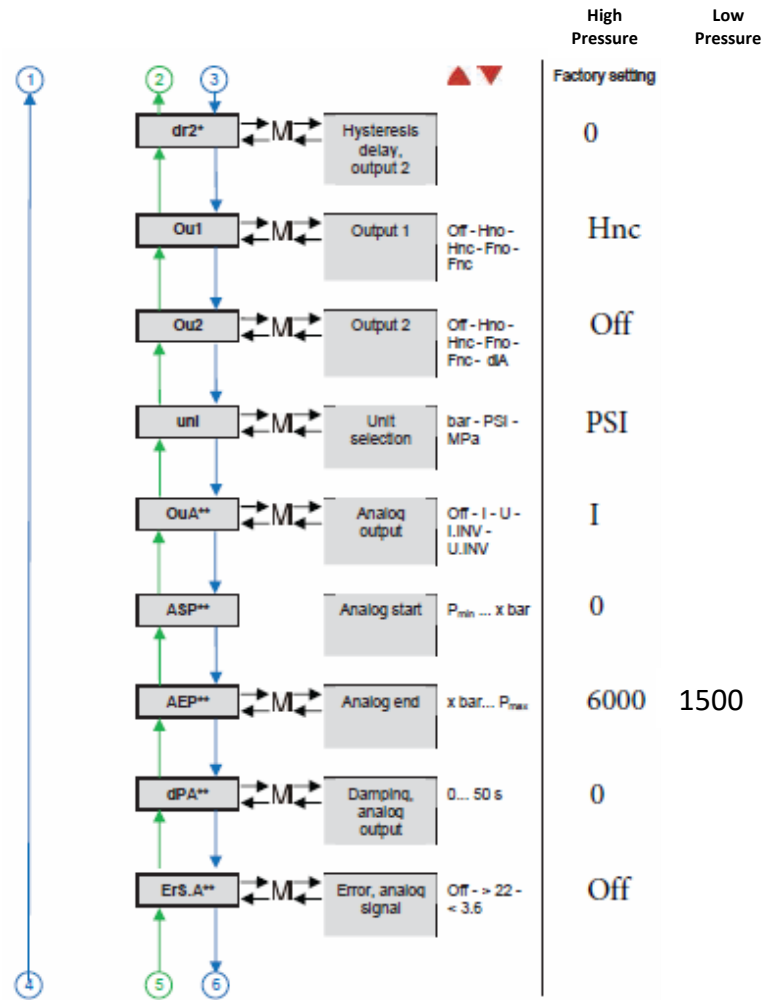
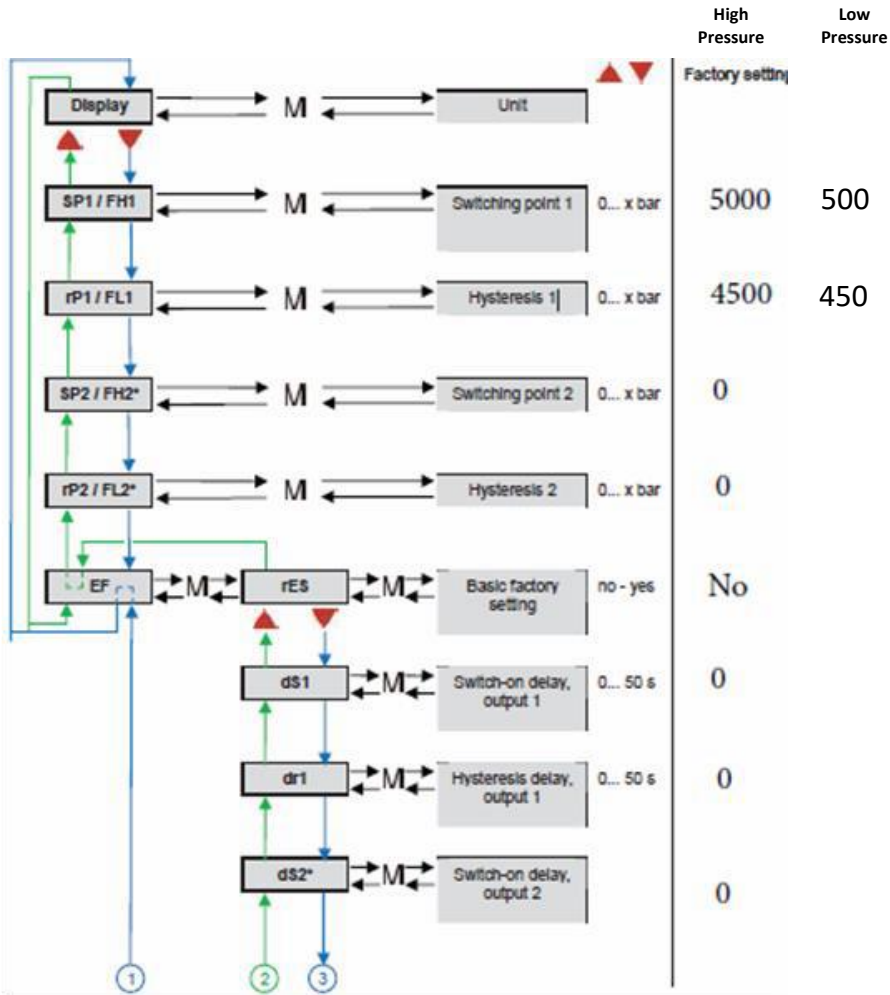

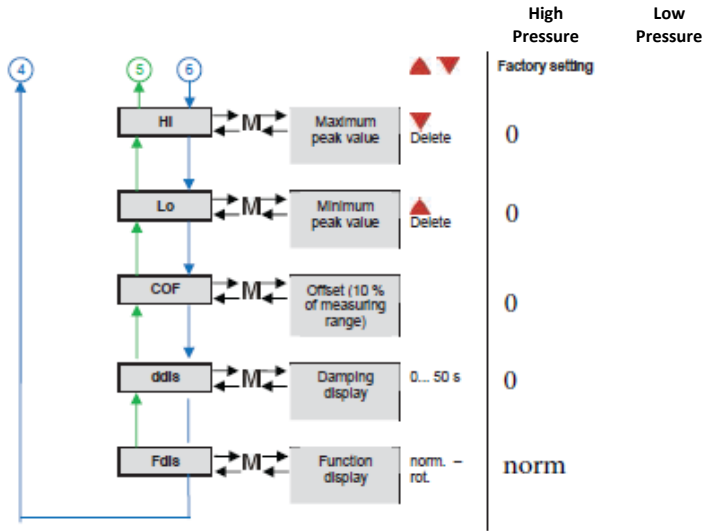

\* only models with 2nd switching contact  
 \*\* only models with analog output  
 \*\*\* setting according to measuring range

**Lock**

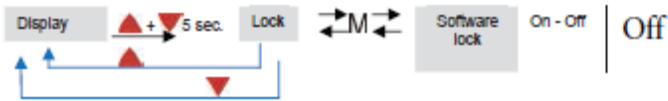

## 8 Maintenance/Cleaning

### Maintenance

The pressure switch requires no maintenance.

**WARNING**

Check the switch for functioning at regular intervals.  
 If the switch does not work properly, stop operation immediately.

### Cleaning

**CAUTION**

The switch may be damaged by the use of unsuitable cleaning agents.

The following cleaning agents may be used to clean polycarbonates:

- Mild soap or detergents
- Isopropyl alcohol

After cleaning, immediately rinse with water. Do not leave cleaners on surfaces of products.

Do not clean products at elevated temperatures or under direct sunlight.

The following cleaning agents are known to affect the integrity of polycarbonate components and should not be used:

- ZEP Fast 505, Pinesol, Formula 409
- Brake Cleaner
- Halogenated solvents (benzene, gasoline, acetone or carbon tetrachloride)
- Strong alkaline
- MEK (methyl ethyl ketone)
- Abrasive substances

## 9 Decommissioning

**DANGER**

Only remove the switch when deenergized (electrically and hydraulically/pneumatically).  
 Disconnection of the switch from pressure and power supply must be carried out by trained or instructed personnel according to state-of-the-art standards.

**WARNING**

Be aware of the fact that in case of operation with higher temperatures the casing surface may become very hot!