

# OPERATING INSTRUCTIONS

## Vektek Electronic Pressure Switch: 70740075



**The Productivity Devices Company**



1	General information.....	1
2	Structure and function.....	2
3	Safety.....	4
4	Transport, packaging and storage.....	8
5	Commissioning, operation.....	9
6	Faults.....	19
7	Maintenance and cleaning.....	23
8	Disassembly, return and disposal.....	24
9	Technical data.....	26

VEKTEK LLC  
1334 E. 6<sup>th</sup> Ave  
Emporia, Ks 66801  
USA  
Phone: 913-365-1045 (sales)  
Fax: 816-364-0471 (sales)  
620-342-7637 (technical service)  
Email: [sales@vektek.com](mailto:sales@vektek.com)  
Website: [www.vektek.com](http://www.vektek.com)

		IS	7079
REV.	A	EFF. DATE	1/10/24
ECN NO.		5160	
BY / DATE:		KR	12/01/23
APPR. / DATE:		BCD	12/01/23
REV APPR. / DATE:			

## 1. General information

- The device described in the operating instructions was designed and manufactured in accordance with current state-of-the-art technology. All components are subject to strict quality and environmental criteria during production. Our management systems are certified in line with ISO 9001 and ISO 14001.
- These operating instructions provide important information on how to use the device. Adherence to all the specified safety notes and guidelines is a prerequisite for working safely.
- You must comply with any local work safety regulations and general safety specifications applicable to the use of the device.
- They constitute an integral part of the product and should be stored in the direct vicinity of the device so they remain accessible to the technical personnel at all times. Give the operating instructions to any future users or owners of the device.
- The technical personnel must read through these operating instructions carefully and understand them before starting any work.
- The general business conditions in the sales documents apply.
- We reserve the right to make technical modifications.
- More information:  
Internet address: [www.sick.com](http://www.sick.com)  
Associated data sheet: 8024860

## 2. Structure and function

### 2.1 Scope of delivery

- Pressure switch
- Operating instructions
- Test report
- Compare the scope of delivery with the delivery note.

### 2.2 Overview



- ① INFO pushbutton
- ② Digital display
- ③ Status display, switching outputs
- ④ MENU pushbutton
- ⑤ Confirmation pushbutton
- ⑥ Electrical connection
- ⑦ Process connection, spanner flat
- ⑧ Process connection, thread

## 2.3 Display and control unit

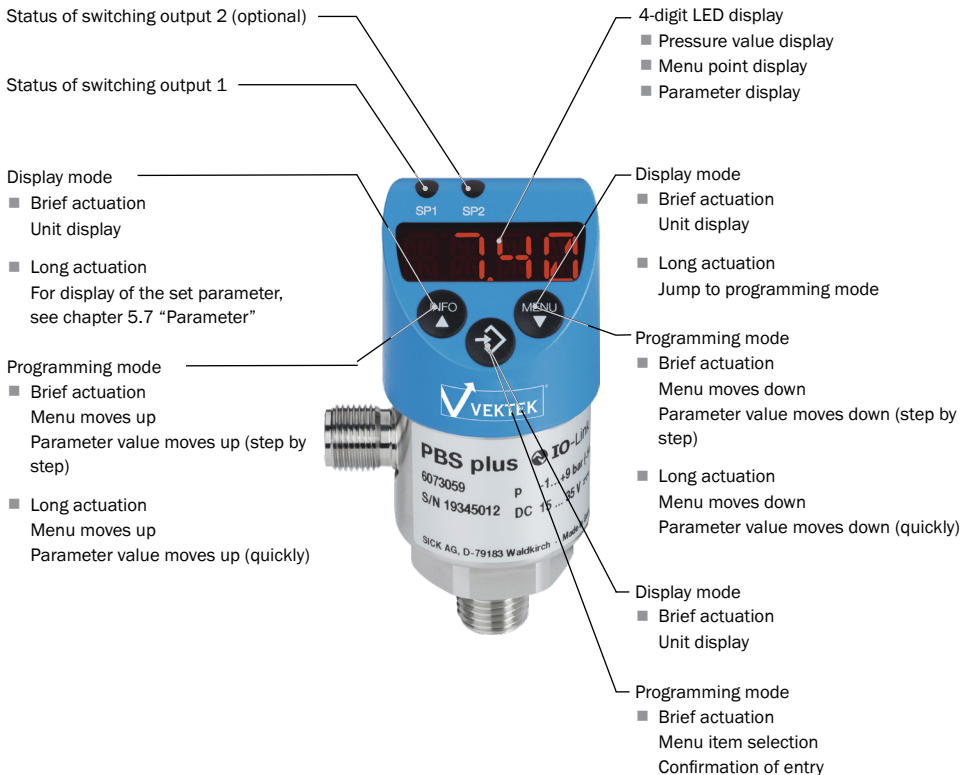

## 3. Safety

### 3.1 Explanation of icons

**WARNING!**

... indicates a potentially dangerous situation, which may lead to a fatality or serious injuries if not prevented.

**CAUTION!**

... indicates a potentially dangerous situation, which may lead to minor/slight injuries or property or environmental damage if not prevented.

**WARNING!**

... indicates a potentially dangerous situation which could lead to burns caused by hot surfaces or liquids if not prevented.

**Information**

... highlights useful tips and recommendations as well as information for efficient and trouble-free operation.

### Conformities and certificates

You can obtain declarations of conformity, certificates, and the current operating instructions for the product at [www.sick.com](http://www.sick.com). To do so, enter the product part number in the search field (part number: see the entry in the “P/N” or “Ident. no.” field on the type label).

### 3.2 Intended use

The device is designed and manufactured exclusively for the intended purpose of use described here and may only be used in accordance with this purpose.

Any claims made due to unintended use are excluded.

#### Purpose

The PBS plus pressure switch is used to switch power circuits depending on the measured pressure. The pressure value can also be output to the respective evaluation units as a standardized signal. The switching conditions can be programmed directly on the pressure switch (switching and resetting points...). Switching conditions and pressure values can be read off using the various display elements.

This is a device of class B for emitted interference and is intended for operation in industrial environments. In other environments, e.g. residential or commercial areas, it could interfere with other devices under certain circumstances. In this case, the operating entity may be required to take appropriate measures.

Only use the pressure switch in applications which are within its technical performance limits (e.g. max. ambient temperature, material compatibility, ...).

→ For performance limits, see Chapter 9 “Technical data”.

#### Technical restrictions

- The overload pressure must not be exceeded at any time, even when faults in the end application occur. Strains exceeding the overload protection can cause measurement errors.
- Pressure surges above the nominal pressure and for less than 1 ms can cause measurement errors.
- The use of a choke is recommended for applications for which pressure peaks occur. The choke restricts the pressure channel to 0.3 mm, thereby increasing the resistance to pressure peaks.

Alternatively, a process connection with reduced channel bore hole (0.3 mm or 0.6 mm) can be used.

- A flush-mounted device version must be used for measuring materials which could clog a channel bore hole (e.g. particle board).
- At high ambient temperatures and high UV radiation, the pressure switch must be installed with additional shading to prevent damage to the digital display and pushbuttons.
- The measuring material temperature in the device must not exceed 85 °C. A cooling line can be helpful for hotter measuring materials.

### 3.3 Personnel qualification

Technical personnel

Due to their specialist training, knowledge of measuring and control technology, and experience, as well as their knowledge of country-specific regulations and the relevant standards and provisions, the technical personnel authorized by the operating entity are able to perform the work described and detect any potential dangers independently.

Special application conditions require other knowledge, e.g. of aggressive media.

### 3.4 Use of accessories and spare parts

We recommend using only original spare parts and original accessories from SICK. The use of accessories and spare parts from third parties could lead to damage to the device or accidents due to shortcomings in quality or other reasons.

SICK does not assume any liability for damages or accidents which occur due to malfunctions or unsuitability of accessories and spare parts which are not produced by SICK (e.g. non-compliance with IP enclosure rating of plug connectors). No warranty claims which are caused by malfunction or unsuitability of accessories or spare parts from third parties can be asserted.

## 3.5 Safety labels

### Icons



Read the operating instructions before mounting and commissioning of the device without fail!

## 4. Transport, packaging and storage



The flush-mounted version is delivered with a special protective cap to protect the membrane.

- Manually remove this protective cap just before mounting to prevent damage to the membrane or the process connection thread.
- Keep the protective cap for storage or transport.
- Mount the protective cap when removing and transporting the device.

### 4.1 Transport

Examine the pressure switch for any damage that may have occurred in transit. Also check the membrane for optical damage when using a flush-mounted version.

Report any obvious damage immediately.

### 4.2. Packaging and storage

Do not remove packaging until immediately before assembly.

Retain the packaging as it offers ideal protection during transport (e.g., when changing the installation site or sending for repair).

Permissible conditions at the storage location:

Storage temperature: -20 ... +70 °C

Humidity: 45 ... 75% relative humidity (no condensation)

Mount the protective cap to protect the membrane before putting into storage.

## 5. Commissioning, operation

### 5.1 Checking device

Do a visual inspection of the pressure switch before commissioning.

- Escaping liquids indicate damage.
- Only use the pressure switch when its safety technology is working perfectly.
- Do an optical inspection for membrane damage, this is a safety-relevant part.

### 5.2 Requirements on the mounting location

The mounting location must fulfill the following conditions:

- Protected from weather influences.
- At high ambient temperatures and high UV radiation, the pressure switch must be installed with additional shading to prevent damage to the digital display and pushbuttons.
- Sealing surfaces are clean and undamaged.
- Sufficient space for safe electrical installation.
- For information on threaded bore holes and weld-in connections, see the technical information at [www.SICK.de](http://www.SICK.de).
- Permissible ambient and measuring material temperatures remain within the performance limits. Take into account possible restrictions on the ambient temperature range due to the mating plug used.
- → For performance limits, see Chapter 9 “Technical data”.

## 5.3 Mechanical mounting

The maximum torque depends on the mounting location (e.g. material and shape). If you have any questions, please consult our application advisor.

→ For contact information, see chapter 1 “General” or the rear side of the operating instructions.

1. Seal sealing surface (→ see “Sealing variants”).
2. Tighten the pressure switch in the mounting location by hand.
3. Tighten via spanner flat using torque wrench.

### Sealing variants

#### Cylindrical thread

Seal sealing surface with SAE 4

O-Ring Boss Seal

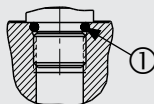

SAE J1926, ISO 725

#### Conical thread

Wrap sealing material around thread

(e.g. PTFE band).

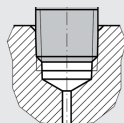

NPT, R and PT

## 5.4 Electrical mounting

### 5.4.1 Requirements on voltage supply

→ For auxiliary energy, see type label

The pressure switch must be supplied by an energy-limited circuit as per 9.4 of the UL/EN/IEC 61010-1 or LPS as per UL/EN/IEC 60950-1 / CSA C22.2 No.60950-1 or class 2 as per UL1310 / UL1585 (NEC or CEC).

The voltage supply must be suited for operation above 2,000 m if the pressure switch is used from this height.

#### 5.4.2 Requirements on the electrical connection

- The enclosure rating of the mating plug corresponds to the enclosure rating of the pressure switch.
- Cable diameter matches the cable gland of the mating plug.
- The cable gland and seals of the mating plug sit correctly.
- No moisture can penetrate into the cable end.

#### 5.4.3 Requirement on shielding and earthing

The pressure switch must be shielded and earthed according to the earthing method of the application.

#### 5.4.4 Connecting the device

1. Assemble the mating plug or the cable output → For connection assignment, see type label
2. Establish plug connection.

### Electrical connections

		Round connector M12x1, 5-pin				
						
		2 switching outputs + 1 analog output				
		L+ = 1	M = 3	Q1 = 4 C/Q1 = 4	Q2 = 5	Q <sub>A</sub> = 2
Enclosure rating as per IEC 60 529	IP 67					
	<b>The enclosure ratings specified apply only with male cable connectors of the corresponding enclosure rating when plugged in.</b>					

## 5.5 Zero point adjustment

Check the zero point shown on the digital display during commissioning. If, for installation reasons, a zero point offset is displayed, this can be reset in programming mode using the OSET parameter. Run zero point adjustment for gauge pressure and vacuum measurement ranges in a de-pressurized state.



Run zero point adjustment of absolute pressure measurement ranges at 0 bar absolute (vacuum). Since corresponding references are required for this purpose, we recommend only having this done by the manufacturer.

## 5.6 Operating modes

Mode	Programming mode
System start	Digital display is completely controlled for 1 sec. When starting up the pressure switch in the hysteresis range, the output switch is set to “not active” by default
Programming mode (Setting of parameters)	Activate programming mode Actuate the “MENU” pushbutton for about 5 sec. If password ≠ 0000 is set, a password request occurs. If confirmation is successful, access to programming mode is granted; otherwise the system jumps back to display mode.  Timeout If no pushbutton is pressed for 60 s when a parameter is being set, the device returns to the display mode with the value unchanged.
Display mode (Normal working operation, pressure value display)	Return to display mode Simultaneous actuation of “INFO” and “MENU”

## 5.7 Overview of parameters

Menu item	Description	Parameter	Factory setting
SP1 / SP2	Hysteresis function: Switching point (switching device 1 / 2)	0.25 ... 100% of the measuring range	5000 / 5000
FH1 / FH2	Window function: Window High (switching output 1 / 2)	0.25 ... 100% of the measuring range	5800 / 5800
RP1 / RP2	Hysteresis function, reset switching point, switching output (1, possibly 2)	0 ... (switching point - 0.25% of the measuring range)	4500 / 4500
FL1 / FL2	Window function: Window Low switching output (1, possibly 2)	0 ... (Window High - 0.25% of the measuring range)	0 / 0
EF	Extended programming functions		
RES	Resetting of the set parameters back to the factory settings	Yes / No	
DS1 / DS2	Switching delay time which must not be interrupted until an electrical signal switch takes place (SP1, possibly SP2)	0.00 ... 65.00 s	0.00 s
DR1 / DR2	Reset switching delay time which must not be interrupted until an electrical signal switch takes place (RP1, possibly RP2)	0.00 ... 65.00 s	0.00 s
OU1 / OU2	Switching function (switching output 1 / 2)	HNO = Hysteresis function, normally open HNC = Hysteresis function, normally closed FNO = Window function, normally open FNC = Window function, normally closed	HNC / FNO
OU3	Output signal switchover	I = 4 ... 20 mA U = DC 0 ... 10 V	I
POL1 / POL2	Switching logic (switching output 1 / 2)	PNP, NPN	PNP
ALOW	Measuring range scaling/Turn down (analog value, start value)	Corresponding analog output	0
AHGH	Measuring range scaling/Turn down (analog value, end value)	Corresponding analog output	5800

Menu item	Description	Parameter	Factory setting
AVGD	Attenuation (digital display)	0.00 ... 65.00 s	0.20 s
AVG1 / AVG2	Attenuation (switching output 1 / 2)	0.00 ... 65.00 s	0.00 s
AVG3	Attenuation (analog signal)	0.00 ... 65.00 s	0.1
UNIT	Unit switchover	BAR, mBAR, MPA, KPA, PSI, KGcm (kg/cm <sup>2</sup> ), %	PSI
OSET	Zero point adjustment / "Auto-zero" version (max. 3% of the range)	Yes / No	No
DISM	Display value in display mode	ACT = Current system pressure LOW, HIGH = Min/Max system pressure OFF = Display off SP1 / FH1 = Set threshold value RP1 / FL1 = Set threshold value SP2 / FH2 = Set threshold value RP2 / FL2 = Set threshold value	ACT
DISU	Update rate (digital display)	1, 2, 5, 10 updates/second	5
DISR	Turn display 180° (digital display)	Yes / No	No
DRES	Resolution (digital display)	OPT = Optimized (stable measurement value display with the rounding factor of the last digit optimized to the measuring range)  FULL = Maximum (finest resolution, an attenuation of the digital display might have to be set for a stable measurement value display)	OPT
RHL	Delete memory (min/max system pressure)	Yes / No	Yes reset after testing
PAS	Password entry	0000 = No password, password entry digit by digit	0000
TAG	Measurement device name (TAG)	32 selectable characters (A-Z ,0 ... 9; - ,EMPTY) (2 spaces in a row end entry and causes this and the character behind it to be deleted)	without

## 5.8 Menu tree

Certain menu items (light gray) are only displayed if the pressure switch features the respective option.

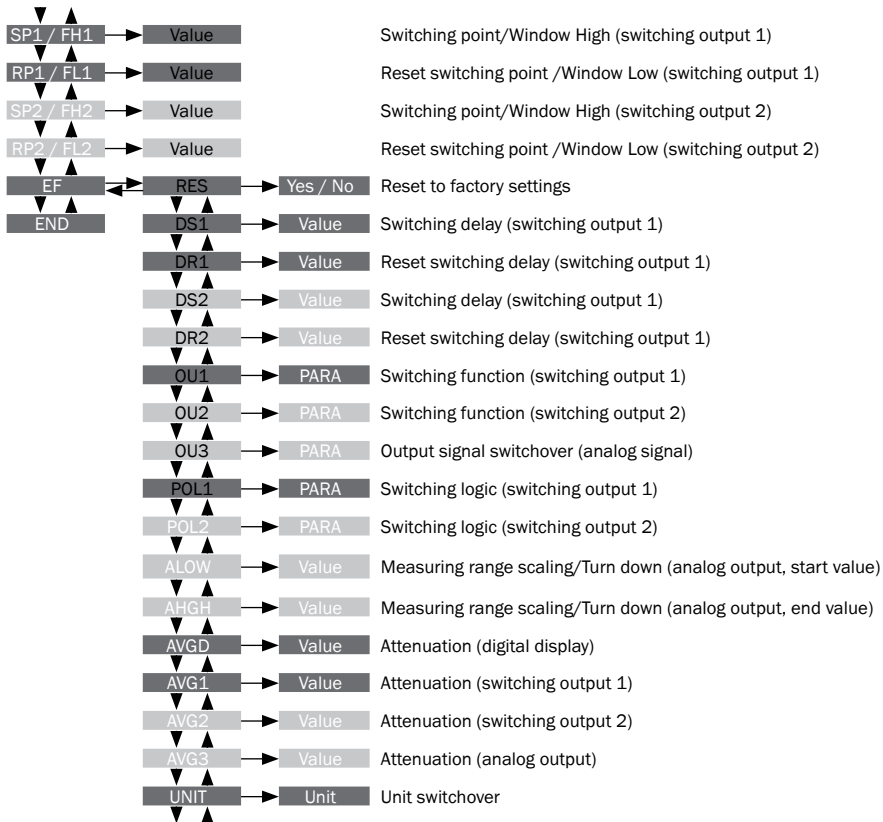

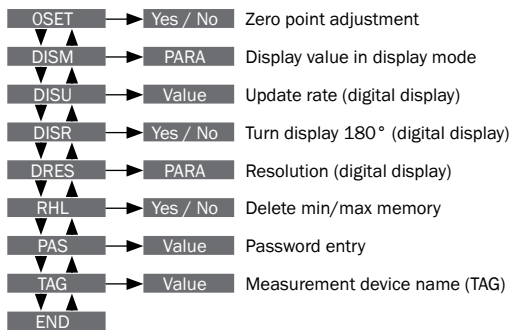

## 5.9 Switching functions

### Hysteresis functions

If the system pressure is fluctuating around the set value, the hysteresis keeps the output state of the outputs stable. In the event of rising system pressure, the output switches upon reaching the switching point (SP).

- N/O contact (HNO): Active
- N/C contact (HNC): Deactivated

If the system pressure drops again, the output does not switch back until the reset point (RP) has been reached.

- N/O contact (HNO): Deactivated
- N/C contact (HNC): Active

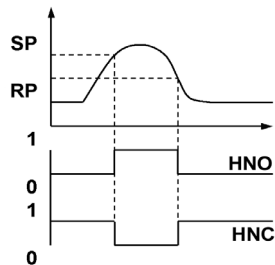

Fig.: Hysteresis function

### Window function

The window function enables monitoring of a defined range. If the system pressure is between window High (FH) and window Low (FL), the output switches.

- N/O contact (FNO): Active
- N/C contact (FNC): Deactivated

If the system pressure is outside window High (FH) and window Low (FL), the output does not switch.

- N/O contact (FNO): Deactivated
- N/C contact (FNC): Active

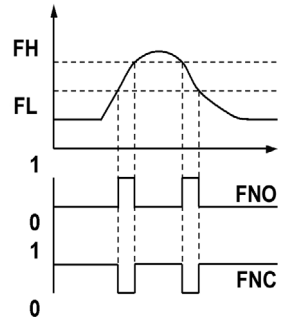

Fig.: Window function

Delay times (0 ... 65 s)

Undesirable pressure peaks of short duration and high frequency can be filtered out in this way.

The pressure must be present for a set time so that the output switches. The output does not change its status immediately when achieving the switching event (SP); instead, it does so after the set delay time (DS).

If the switching result is no longer available after the delay time has expired, the switching output does not change. The output does not reset until the system pressure has fallen to the reset switching point (RP) and at least the set delay time (DR) remains at or below the reset switching point (RP).

If the switching result is no longer available after the delay time has expired, the switching output does not change.

### 5.10 Attenuation function

Time constant "x" specifies the amount of time which the digital display, the switching output or the analog signal needs to approach the end value with a deviation of  $\pm 1\%$  after a measurement value change. After a duration of 2 times "x", the output value has achieved 100% with a deviation of  $\pm 0.01\%$  of the prevailing pressure.

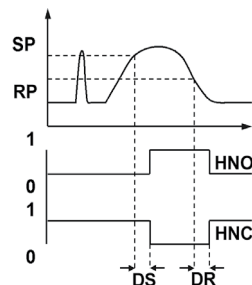

Fig.: Delay times

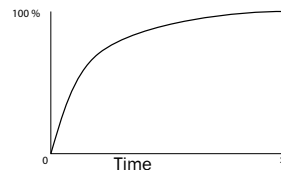

Fig.: Attenuation function

### 5.11 Measuring range scaling (turn down)

In variants with analog signal, the measuring range beginning and measuring range end can be adjusted within the permissible measuring range (do not exceed turn down of 5:1).

### 5.12 Description of IO-Link functionality

IO-Link is a point-to-point connection for communication of the PBS plus to an IO-Link master.

IO-Link specification: Version 1.1

A detailed description of the IO-Link function as well as the device description file (IODD) can be found online on the detailed product page of the pressure switch at [www.sick.com](http://www.sick.com).

## 6. Faults



CAUTION!

### **Bodily injury, property and environmental damage**

If faults cannot be eliminated by the measures listed here, put the pressure switch out of operation immediately.

- Ensure that there is no pressure or signal present and protect against accidental commissioning. If measuring range scaling is set, pressure can be present despite an analog value of 4 mA or 0 V.
- Contact the manufacturer.
- If the product has to be returned, follow the instruction in chapter 8.2 “Returns”.

**WARNING!****Bodily injury, property and environmental damage caused by hazardous measuring materials**

When coming into contact with hazardous measuring materials (e.g. oxygen, acetylene, combustible or poisonous materials), measuring materials which are hazardous to health (e.g. corrosive, poisonous, carcinogenic, radioactive) as well as cooling systems and compressors, there is a risk of bodily injury as well as property and environmental damage.

- In the event of faults, aggressive measuring materials at extreme temperatures and under extreme pressure may be present on the device.
- The relevant regulations must be observed in addition to the general rules for these measuring materials.
- Wear the necessary protective equipment.



For contact information, see chapter 1 “General” or the rear side of the operating instructions.

In the event of faults, check whether the mechanical or electrical installation of the pressure switch is correct.

Processing costs will be charged if the complaint is not justified.

Fault	Possible cause	Measure
No output signal	Line break	Check passage
No output signal	No/Incorrect auxiliary energy	Correct auxiliary energy
No/Incorrect output signal	Wiring error or switchover of switching logic/analog signal	Observe pin assignment Check output configuration Observe pin assignment
Constant output signal during change in pressure	Mechanical overload due to excessive pressure	Exchange device; consult with the manufacture in the event of repeated failure
Deviating zero point signal	Overload pressure limit exceeded	Permissible overload pressure limit upheld
Signal range too small	Mechanical overload due to excessive pressure	Exchange device; consult with the manufacture in the event of repeated failure
Signal range too small	Auxiliary voltage too high/low	Correct auxiliary energy
Signal range falls	Moisture has entered the device	Mount cable correctly
Signal range falls/too small	Membrane damage, e.g. caused by abrasive/aggressive media, corrosion to membrane/process connection	Contact manufacturer and exchange device

## Warnings and errors

Device-internal warnings and errors are output via the digital display. The device continues to measure if there are pending warnings. The output signal and the switching outputs continue to be output.

The following table shows the codes and their meaning.

Warning	Description
ATT1	When the switching point was changed, the reset switching point was automatically lowered by the smallest hysteresis of 0.25% by the device.
ATT2	Zero point offset, prevailing pressure outside the limits
ATT3	Password entry for menu access faulty
ATT4	Unit cannot be shown on the display, previous unit is used

Warning	Description
ATT5	Maximum turn down exceeded
ILOC	Menu locked by IO-Link
OL	Overload pressure, measuring range exceeded > about 3.125% (digital display flashes)
PAS	Request for password entry
UL	Underload pressure, measuring range undercut < about 3.125% (digital display flashes)

Error	Description
ERR	Internal error (device restart or reset to factory setting could help) The analog output controls the alarm signal $\leq 3.6$ mA (4 ... 20 mA output signal) or $\geq 11$ V (0 ... 10 V output signal) in accordance with NAMUR43 The switching outputs maintain the current switching state (output open or closed)
ERR1	Device temperature exceeded/undercut or auxiliary energy undercut The analog output is output. There are limits regarding accuracy (influence of temperature) and maximum analog value (auxiliary energy undercut) The switching outputs maintain the current switching state (output open or closed)
ERR2	Sensor defect detected, check whether high overload pressure exists (can be detected as sensor defect), a device restart or device exchange may be necessary The analog output controls the alarm signal $\leq 3.6$ mA (4 ... 20 mA output signal) or $\geq 11$ V (0 ... 10 V output signal) in accordance with NAMUR43 The switching outputs maintain the current switching state (output open or closed)
SC	Short-circuit on switching output 1 or 2 detected The affected switching output is deactivated as long as the short-circuit exists

Confirm warnings and errors with confirmation pushbutton.

## 7. Maintenance and cleaning

### 7.1 Maintenance

This pressure switch is maintenance-free.

Repairs may only be carried out by the manufacturer.

### 7.2 Cleaning



#### CAUTION!

Unsuitable cleaning agents

Cleaning with unsuitable cleaning agents can damage the device and type label.

- Do not use aggressive cleaning agents.
- Do not use hard or pointy objects.
- Do not use abrasive cloths or sponges.

Suitable cleaning agents

- Water
- Commercial dishwasher liquid

Cleaning the device

Wipe the device surface with a soft, damp cloth.

## 8. Disassembly, return and disposal

### 8.1 Disassembly



#### WARNING!

#### **Bodily injury, property and environmental damage caused by hazardous measuring materials**

When coming into contact with hazardous measuring materials (e.g. oxygen, acetylene, combustible or poisonous materials), measuring materials which are hazardous to health (e.g. corrosive, poisonous, carcinogenic, radioactive) as well as cooling systems and compressors, there is a risk of bodily injury as well as property and environmental damage.

- In the event of faults, aggressive measuring materials at extreme temperatures and under extreme pressure may be present on the device.
- Wear necessary protective equipment.



#### WARNING!

#### **Risk of burns**

During removal, there is risk that hot, dangerous measuring materials will escape. The pressure switch can heat up due to hot measuring materials.

- Let the device cool sufficiently before removal.
- Wear necessary protective equipment.

#### Disassembling the device

1. De-pressurize and de-energize the pressure switch.
2. Disconnect electrical connection.
3. Remove the pressure switch via the spanner flat using the socket wrench.

## 8.2 Returns

When returning the device, it is crucial to note the following:

All devices delivered to SICK must be free from hazardous substances (acids, lyes, solutions, etc.) and must therefore be cleaned before they are returned. A corresponding declaration of clearance must be enclosed with the sensor. You will find this on our Internet page.



### WARNING!

**Bodily injury, property and environmental damage caused by measuring material residues**

Measuring material residues in the removed device could be hazardous to persons, equipment and the environment.

- If there are hazardous materials, enclose the safety data sheet for the respective measuring material.
- Clean device, see chapter 7.2 “Cleaning”.

The device must be returned in its original packaging or packaging that is suitable for transport purposes.



You can find information on returns in the “Service” section on our local Internet page.

## 8.3 Disposal

Incorrect disposal could endanger the environment.

Dispose of device components and packaging materials in compliance with country-specific waste treatment and disposal regulations and in an environmentally-friendly manner.

## 9. Technical data

### Technical data

#### Measuring range

Measuring range	See type label
Overload protection	Overload protection refers to the sensor element used. Depending on the process connection and seal used, the overload protection could be limited. $\leq 600$ bar (< 8,702 psi): 2-fold $1,000$ bar (14,504 psi): 1.5-fold
Increased overload protection (option)	Deviating temperature errors, signal noise and long-term stability occur with increased overload protection.
Vacuum-tight	Yes

#### Digital display

Type	14-Segment LED, red, 4-digit, character height 9 mm (0.35 in) Display can be rotated electrically by $180^\circ$
------	---

#### Output signal

Output signal	See type label	
Load resistance	4 ... 20 mA	$\leq 500 \Omega$
	DC 0 ... 10 V	> Max. output voltage / 1 mA
IO-Link (option)	Version 1.1	

Zero point adjustment	Max. 3% of the range
-----------------------	----------------------

Analog output/Switching output attenuation	Can be configured from 0 ms ... 65 s
--	--------------------------------------

Power-up delay	1 s
----------------	-----

Switching thresholds	Switching point 1 and switching point 2 can each be adjusted individually
----------------------	---

Switching functions	Normally open, normally closed, window, hysteresis (freely adjustable)
---------------------	--

Switching voltage	Auxiliary energy – 1 V
-------------------	------------------------

Switching current	Max. 250 mA
-------------------	-------------

Technical data		
Setting timer/ Response time	Analog signal: $\leq 5$ ms Switching output: $\leq 5$ ms	
Service life	100 million switching changes	
Voltage supply		
Auxiliary energy	DC 15 ... 35 V  The pressure switch must be supplied by an energy-limited circuit as per 9.3 of the UL/EN/IEC 61010-1 or LPS as per UL/EN/IEC 60950-1 or class 2 as per UL1310 / UL1585 (NEC or CEC). The voltage supply must be suited for operation above 2,000 m if the pressure switch is used from this height.	
Power consumption	Max. 45 mA for versions without 4 ... 20 mA output signal Max. 70 mA for versions with 4 ... 20 mA output signal	
Total power consumption	Max. 600 mA including switching current	
Accuracy information		
Accuracy, analog signal	$\leq \pm 0.5\%$ of the range  Inclusive of non-linearity, hysteresis, zero point and full-scale error (corresponds to error of measurement as per IEC 61298-2).	
Non-repeatability, analog signal	$\leq 0.1\%$ of the range (IEC 61298-2)	
Long-term drift, analog signal	$\leq \pm 0.1\%$ of the range (IEC 61298-2) $\leq \pm 0.2\%$ of the range (IEC 61298-2) for measuring ranges $\leq 0.6$ bar (9 psi), flush-mounted process connection, increased overload protection	
Turn down, analog signal	In the range of max. 5:1, the analog output signal can be freely scaled. If a turn down is set, proportionally increased measurement deviations and temperature errors apply.	
Accuracy, signal output	$\leq \pm 0.5\%$ of the range	
Temperature error in nominal temperature range	Maximal: $\leq \pm 1.5\%$ of the range Maximal: $\leq \pm 2.5\%$ of the range for increased overload protection and flush-mounted versions	
Temperature coefficients in nominal temperature range	Average TC zero point	$\leq \pm 0.16\%$ of the range / 10 K
	Average TC range	$\leq \pm 0.16\%$ of the range / 10 K

### Technical data

#### Reference conditions (as per IEC 61298-1)

Ambient temperature	15 ... 25 °C (59 ... 77 °F)
Air pressure	860 ... 1,060 mbar (12.5 ... 15.4 psi)
Air humidity	45 ... 75% r.h.
Auxiliary energy	DC +24 V
Installation position	Calibrated with vertical installation with the process connection pointing downwards

#### Application conditions

Permitted Temperature ranges	Measuring material: -20 ... +85 °C (-4 ... +185 °F)
	Environment: -20 ... +80 °C (-4 ... +176 °F)
	Storage: -20 ... +70 °C (-4 ... +158 °F)
	Nominal temperature: 0 ... 80 °C (32 ... 176 °F)
Vibration resistance	20 g, 10 ... 2,000 Hz (IEC 60068-2-6, with resonance)
Shock resistance	50 g, 6 ms (IEC 60068-2-27, mechanical)
Mechanical service life	100 million load changes (10 million load changes for measuring ranges > 600 bar (8,702 psi))
Enclosure rating	IP65 and IP67 The enclosure ratings specified (as per IEC 60529) apply only with mating plugs of the corresponding enclosure rating when plugged in.
Installation position	Flexible
Contamination rating	max. 3
Air humidity	≤ 45 ... 75% r.h.
UV radiation	At high ambient temperatures and high UV radiation, the pressure switch must be installed with additional shading to prevent damage to the digital display and pushbuttons.

### Technical data

#### Electrical connection

Plug connector	M12 round connector x 1 (4-pin or 5-pin)
Short-circuit resistance	S+ / SP1 / SP2 to U-
Reverse polarity protection	U+ to U-
Insulation voltage	DC 500 V
Over voltage protection	DC 40 V
Pin assignment	See type label

#### Materials

Parts in contact with measuring material	< 10 bar (145 psi): 316L ≥ 10 bar (145 psi): 316L, PH steel	
Parts not in contact with measuring material	Housing	304
	Keyboard	TPE-E
	Display pane	PC
	Display head	PC+ABS blend
	Pressure transmission medium	Synthetic oil for all gauge pressure measuring ranges < 10 bar (145 psi), all absolute pressure measuring ranges and flush-mounted versions (< 16 bar (232 psi) with increased overload protection).

#### Process connections

Standard	Threaded size	Overload limit	Seal
SAE J1926, ISO 725	SAE 4	1,000 bar (14,500 psi) NBR	
ANSI/ASME B1.20.1	¼ NPT 1)	1,000 bar (14,500 psi)	-

Other process connections available with adapters.

### Dimensions in mm (inch)

Pressure switch with round connector M12 x 1 (5-pin)

<sup>1)</sup> Optionally suited for oxygen, free of oil and grease.

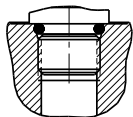
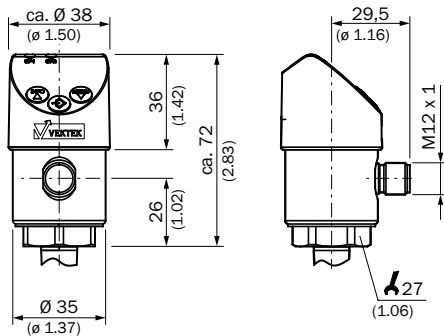

SAE J1926, ISO 725

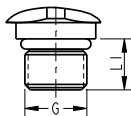

SAE 4 O-Ring Boss

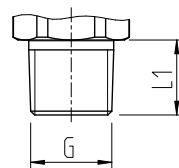

G	L1
SAE 4 J1926	9.1 (.36)

G	L1
¼ NPT	13 (0.51)



***The Productivity Devices Company***

VEKTEK LLC  
1334 E. 6<sup>th</sup> Ave  
Emporia, Ks 66801  
USA

Phone: 913-365-1045 (sales)  
Fax: 816-364-0471 (sales)  
620-342-7637 (technical service)

Email: [sales@vektek.com](mailto:sales@vektek.com)  
Website: [www.vektek.com](http://www.vektek.com)