

1

2

3

4

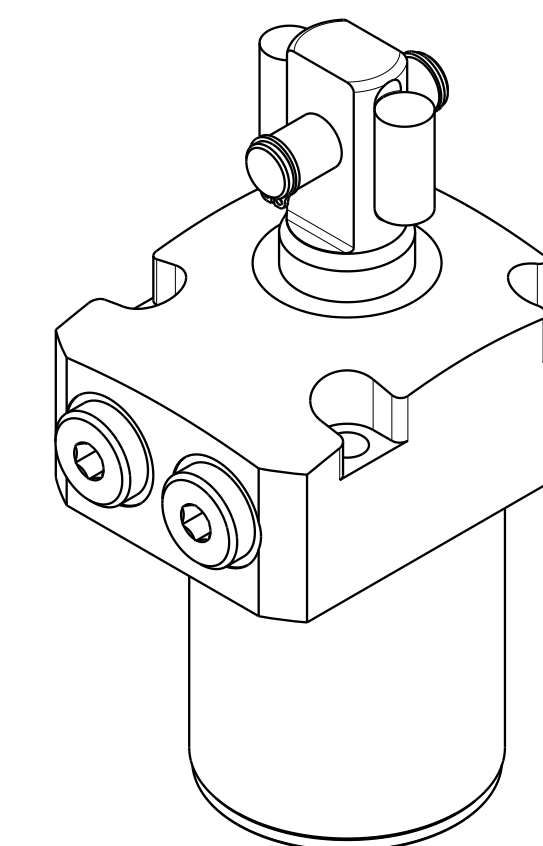
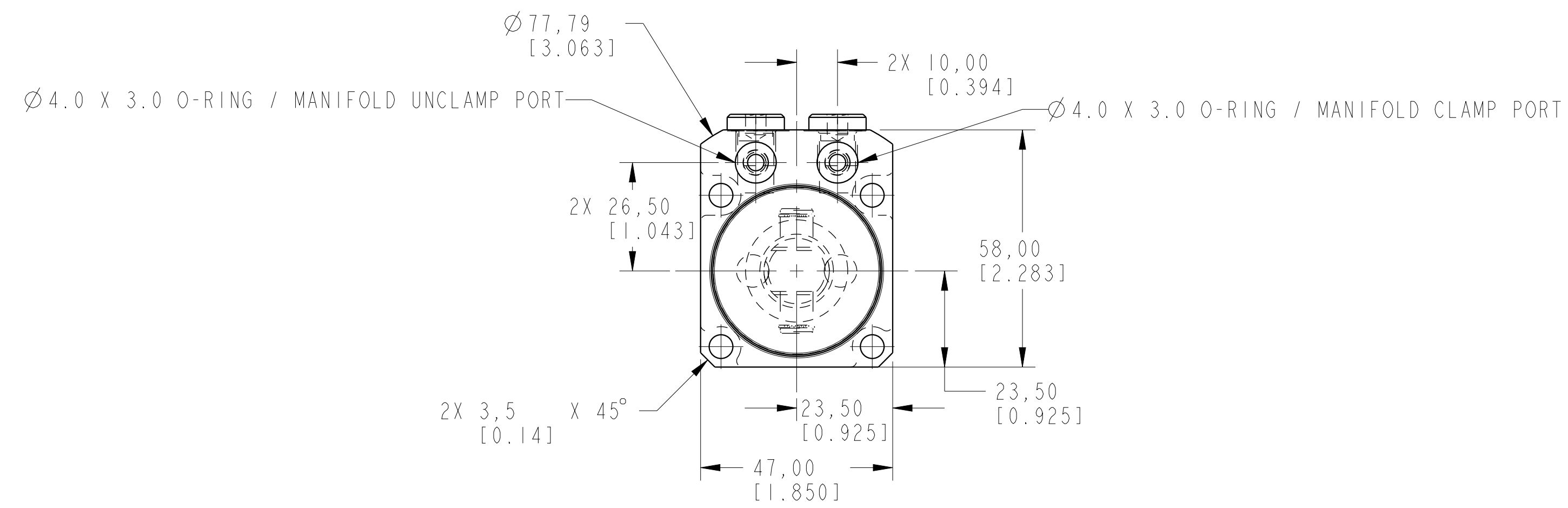

ILCML1403210R0 REV A ECN 2714

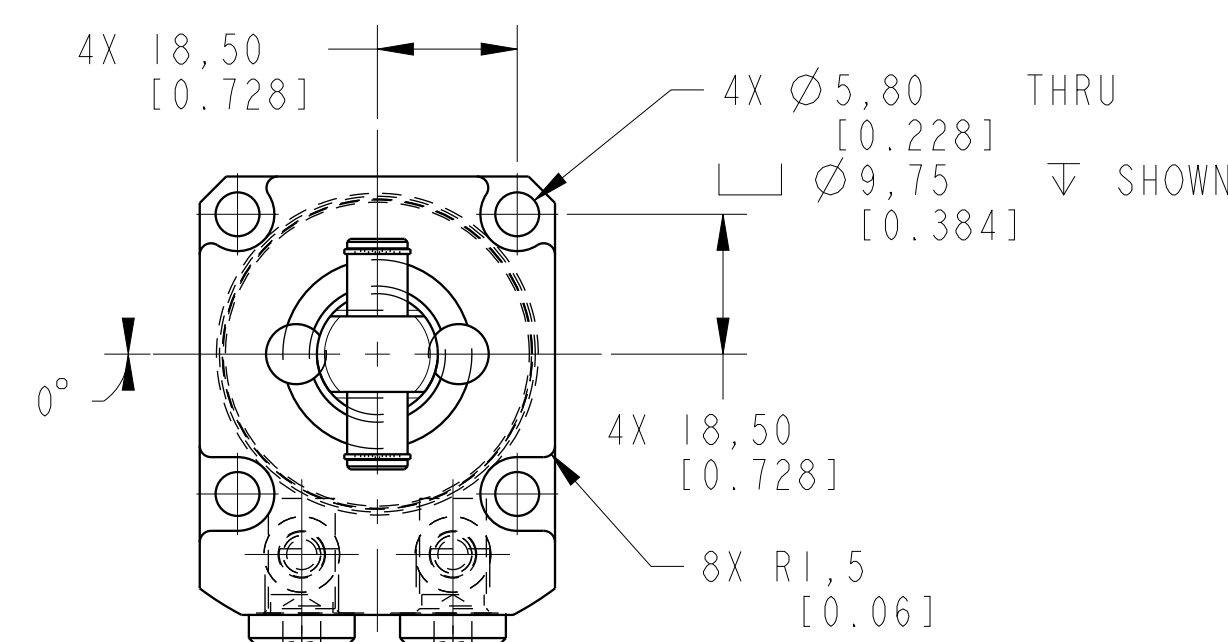
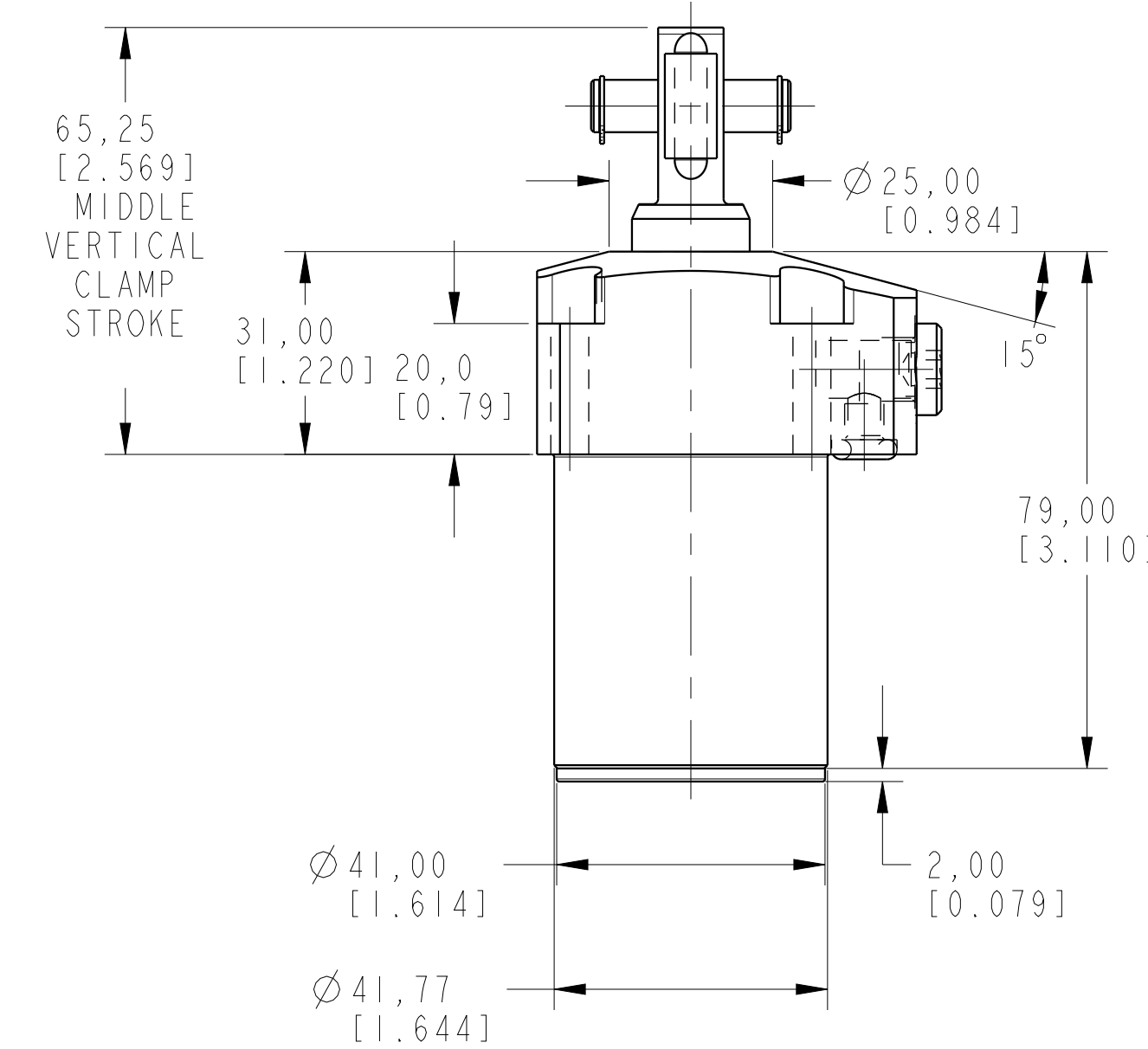
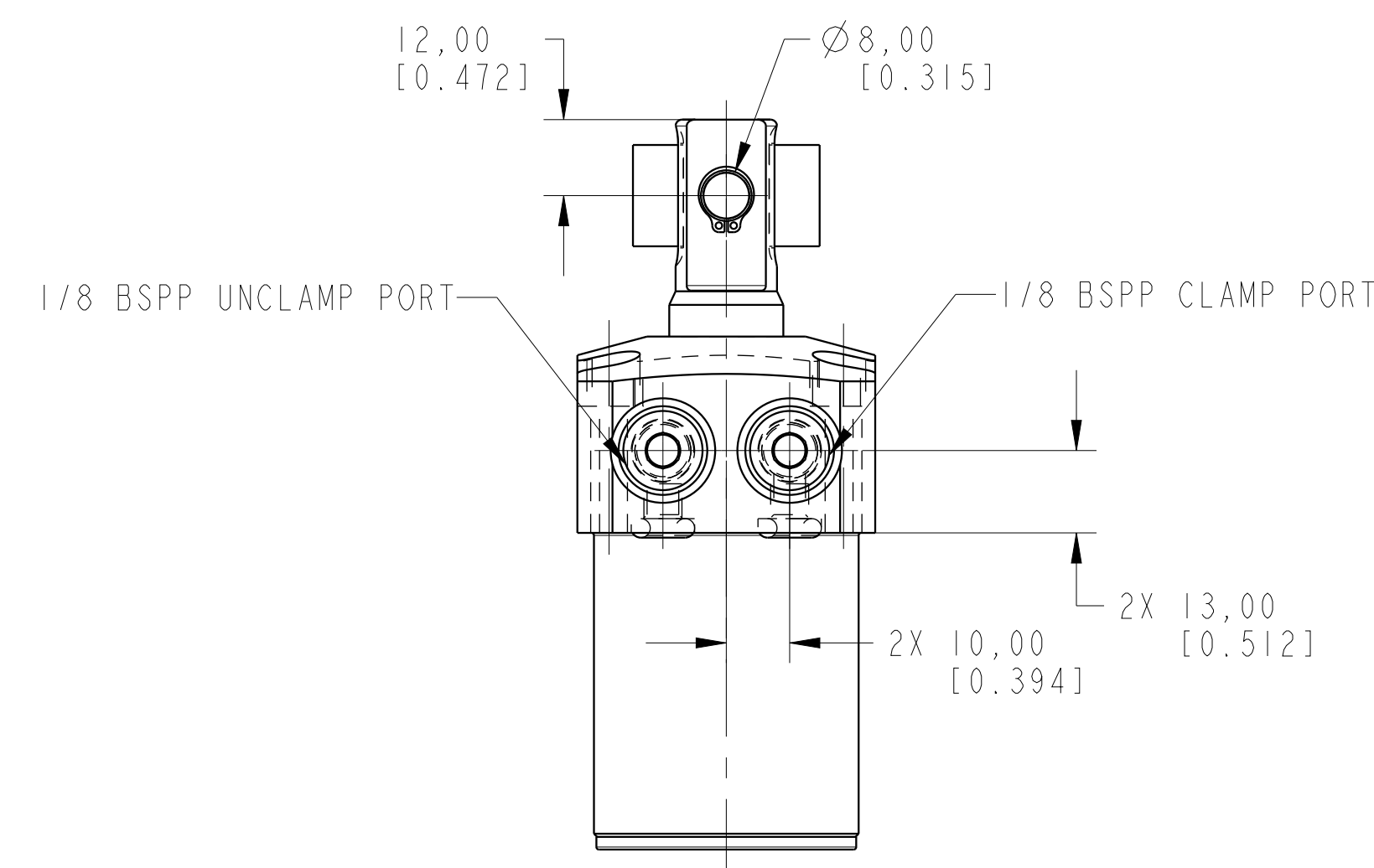
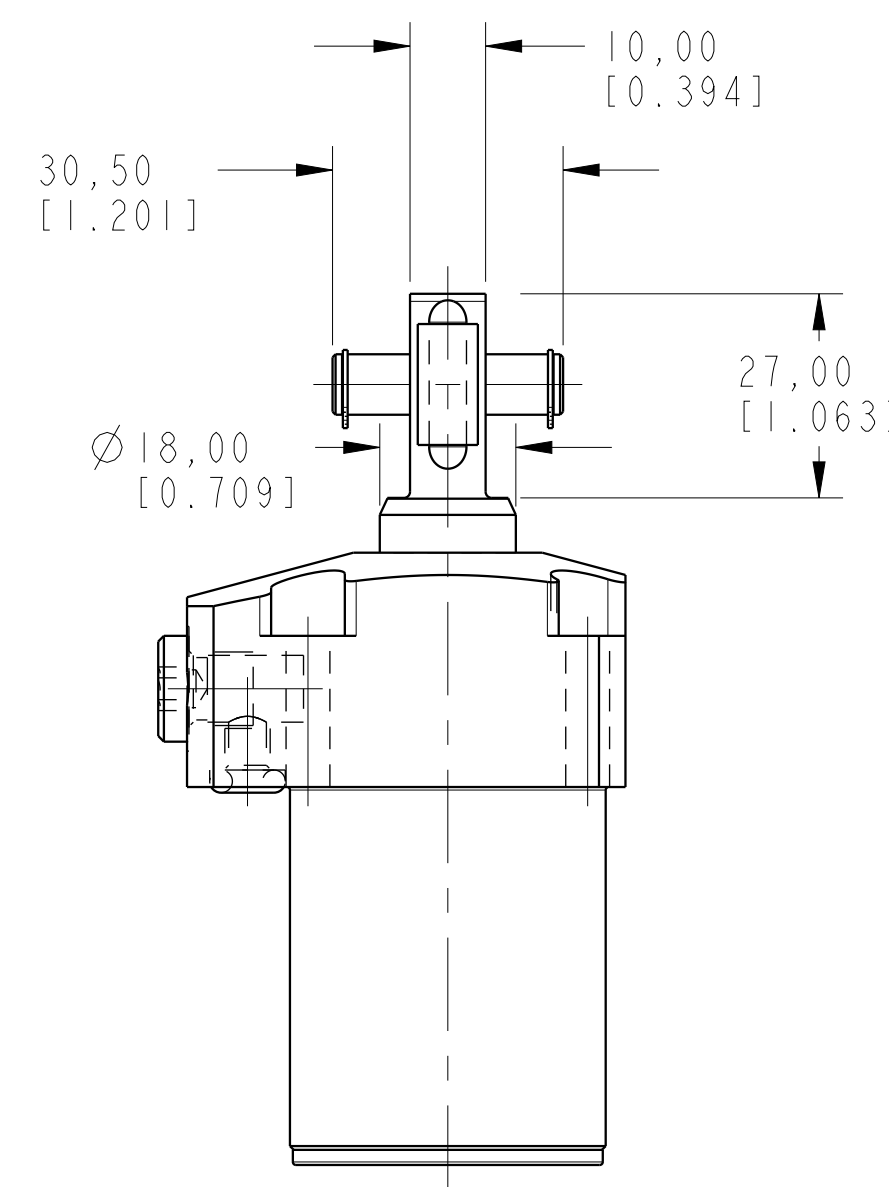

CAD CONTROL DRAWING

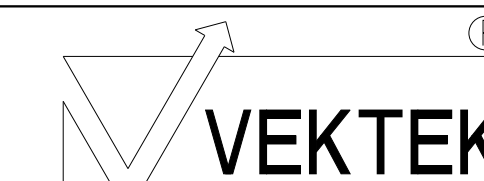

VEKTEK, INC.  
1334 E. SIXTH AVE. P.O. BOX 625  
EMPORIA, KS. 66801 U.S.A.

A	2714	RELEASE	MAJ	3-25-15
REV	IN ACCORDANCE WITH ECN	EFFECTIVE DATE	REVISED BY	DATE
DRW BY:	ALUTHI	DRAWING STATUS: <b>Released</b>		
DATE:	8-13-14	PRODUCTION APPROVED FOR RELEASED STATUS ONLY		

LI-4032-10-R-0	A
REFERENCE MODEL	REF REV
TOLERANCES DO NOT APPLY DIMENSIONS ARE NOMINAL	

SC, TF, 7MPa, 32B, RH, CLEVIS, 0
SIZE D
ILCML1403210R0
REV A