

1

2

3

4

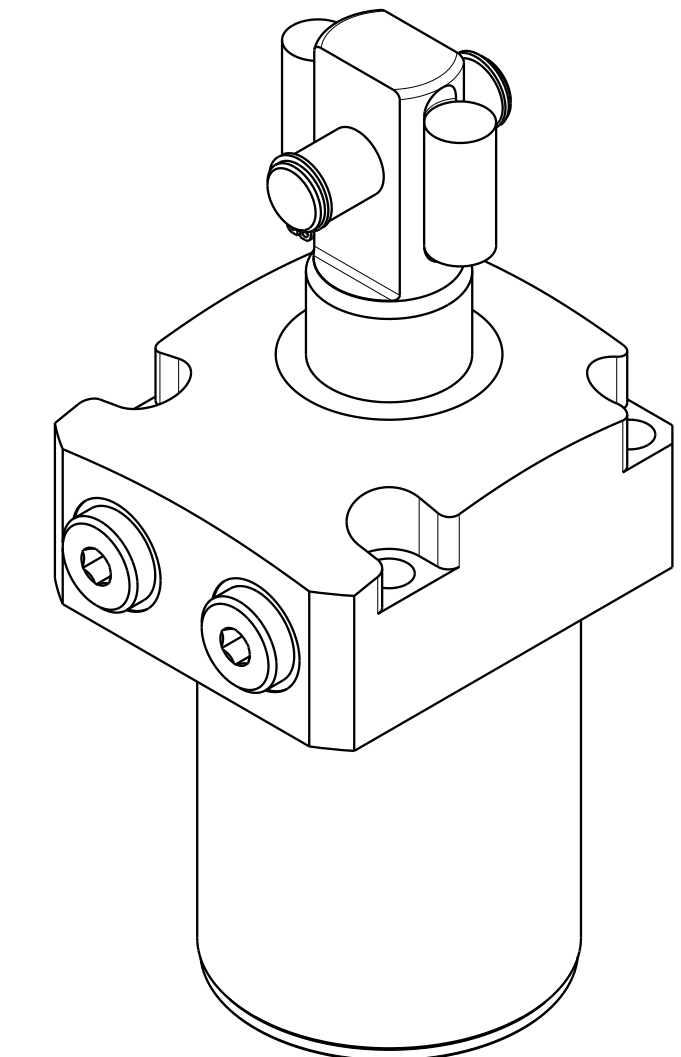
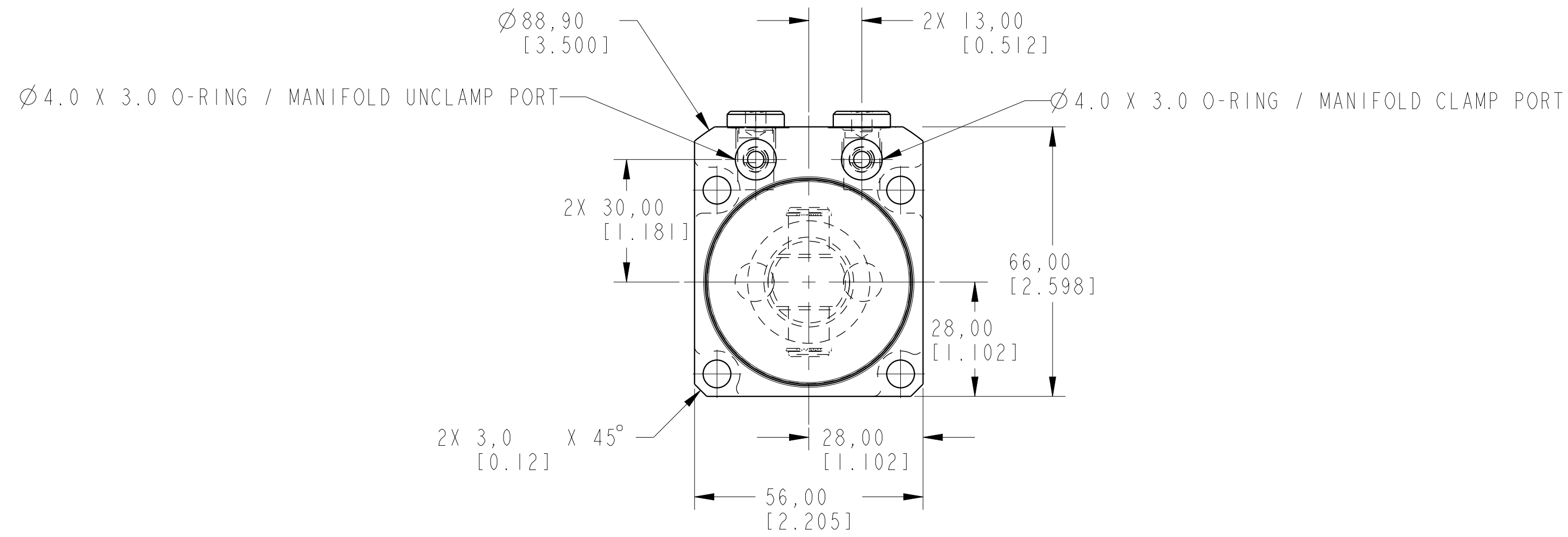

ILCML1404010S0 REV A ECN 2714

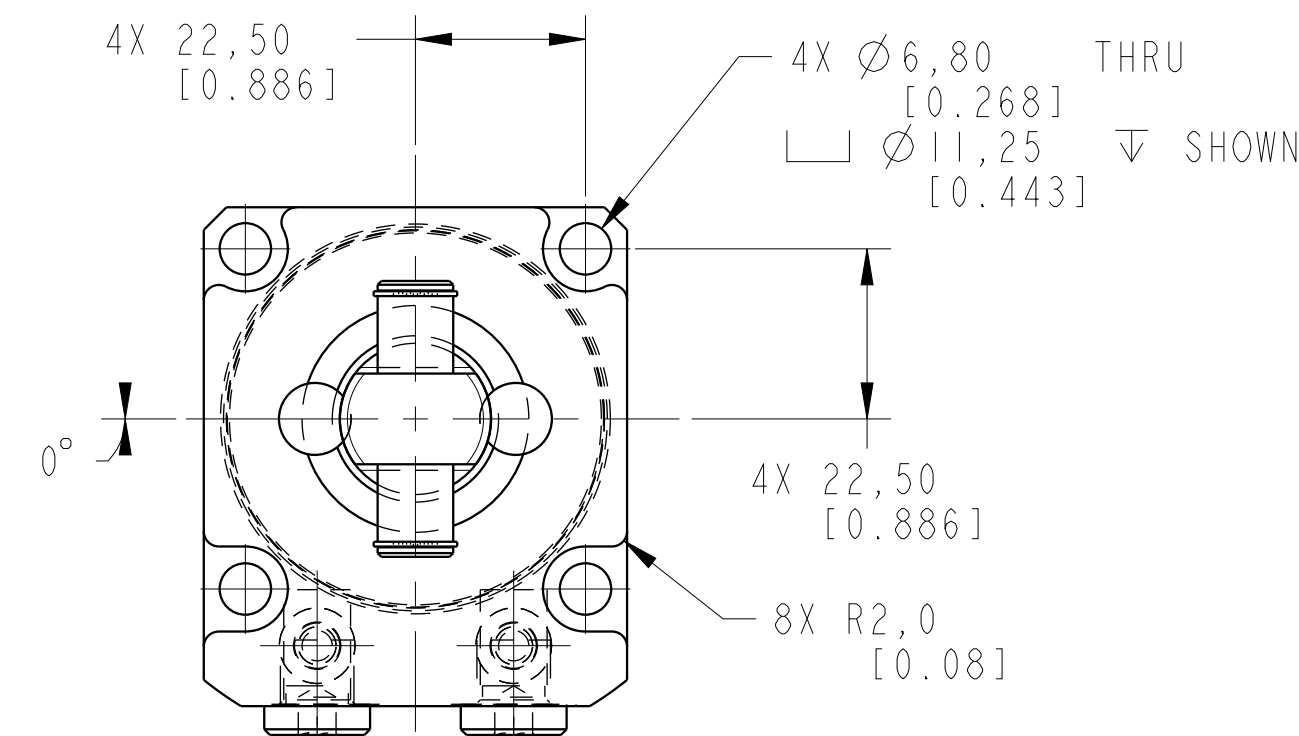
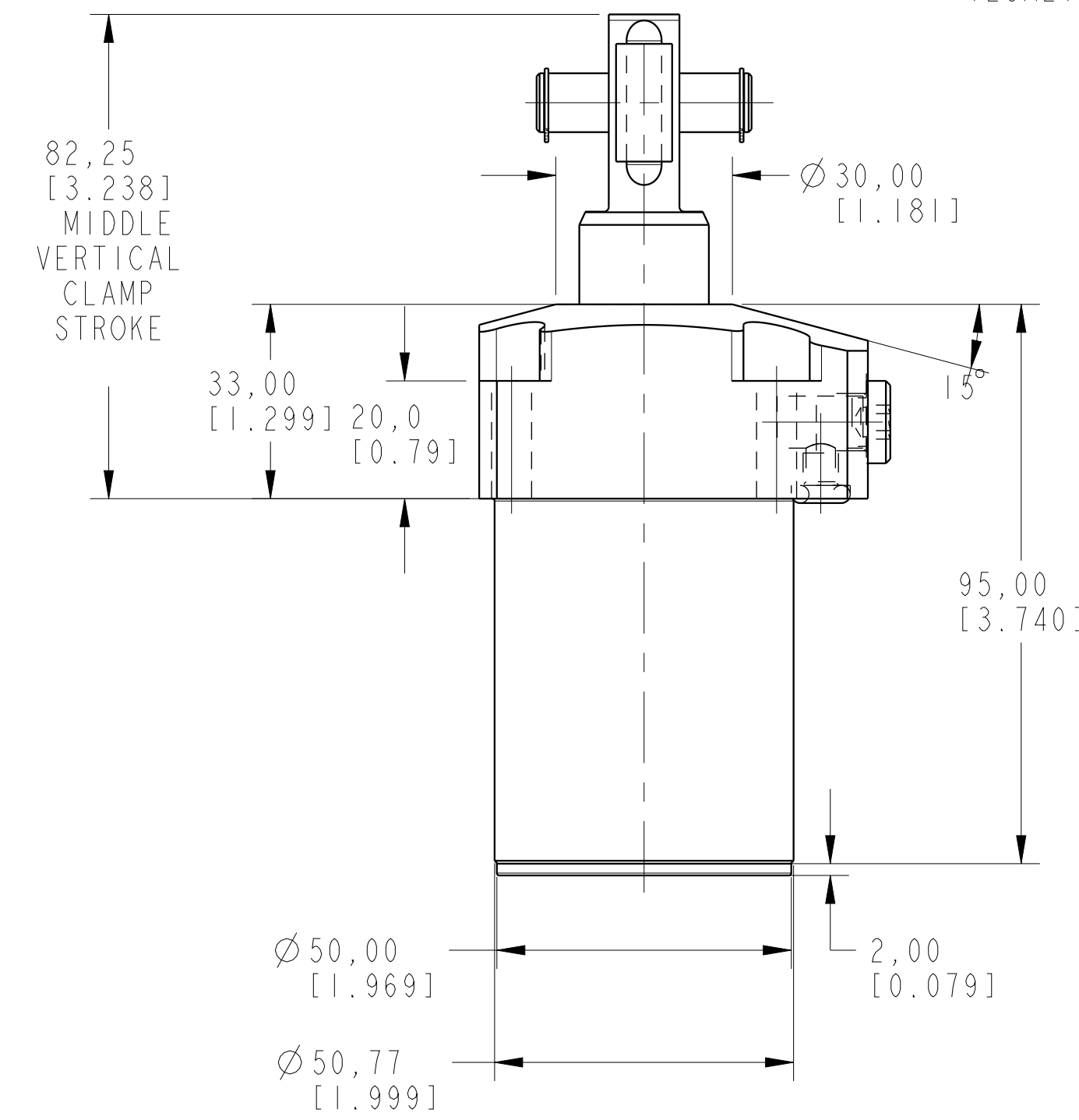
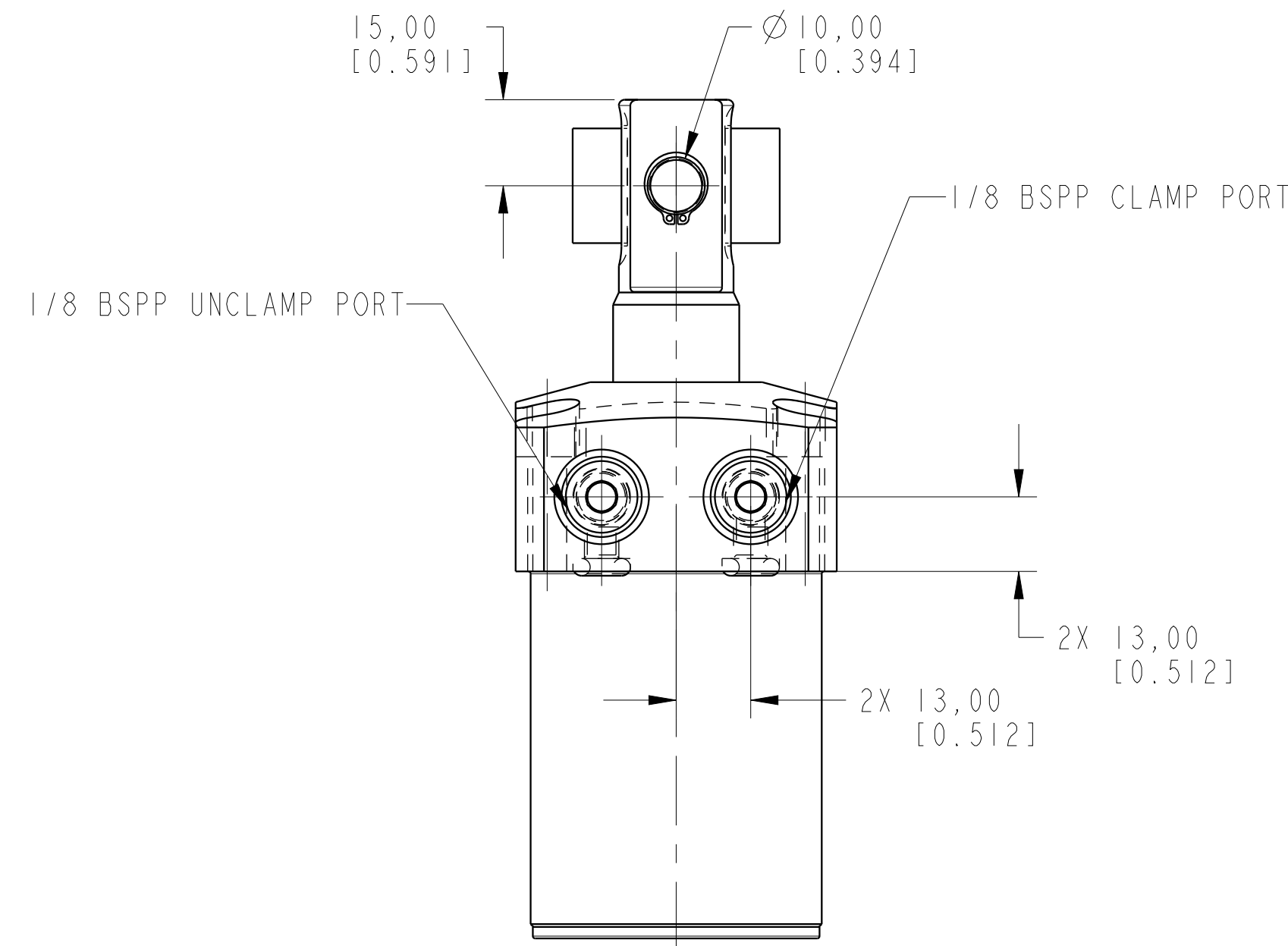
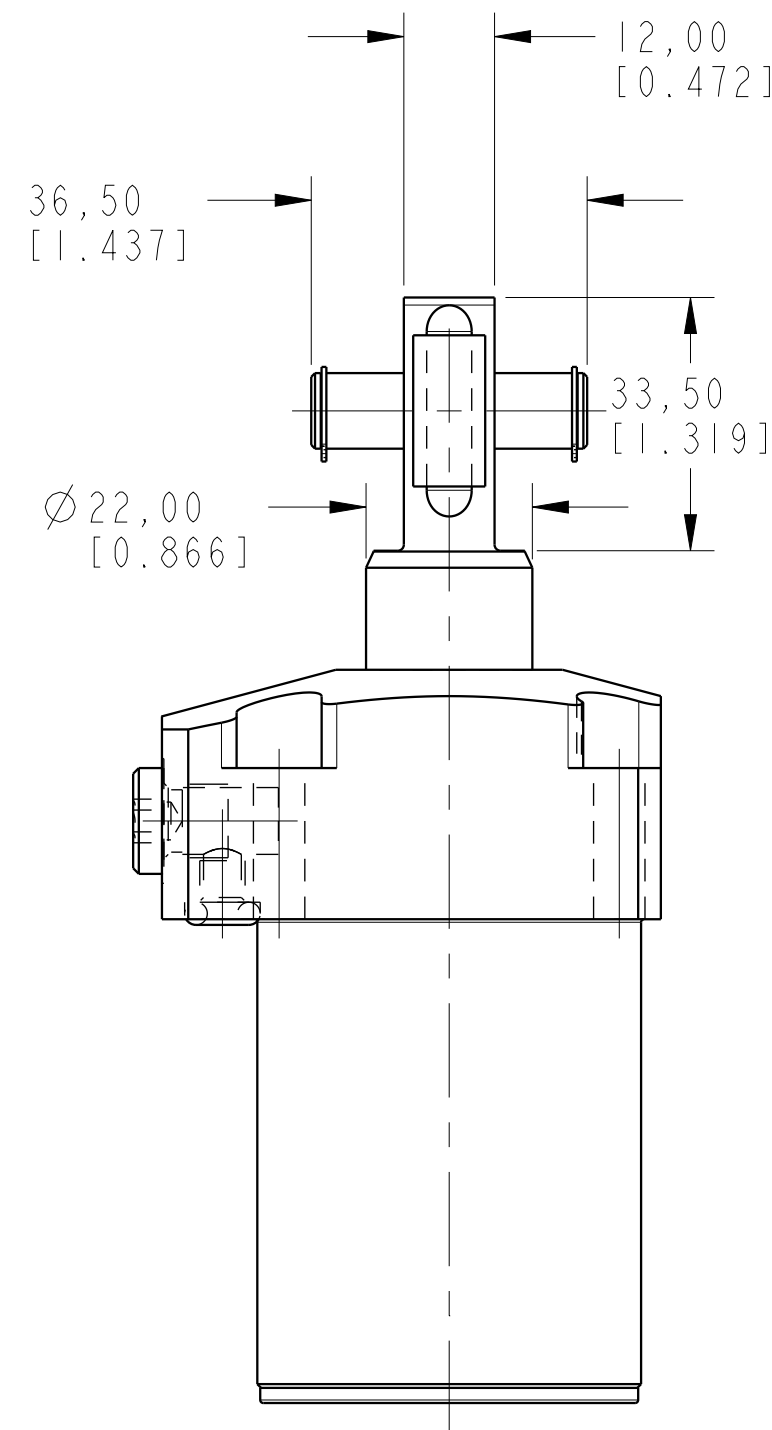

CAD CONTROL DRAWING

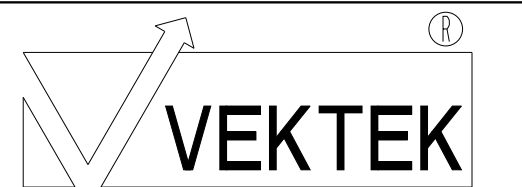

VEKTEK, INC.
1334 E. SIXTH AVE. P.O. BOX 625
EMPORIA, KS. 66801 U.S.A.

A	2714	RELEASE	MAJ	3-25-15	LI-4040-10-S-0	A	SC, TF, 7MPa, 40B, STR, CLEVIS, 0
REV	IN ACCORDANCE WITH ECN	EFFECTIVE DATE	REVISED BY	DATE	REFERENCE MODEL	REF REV	*****
DRW BY:	ALUTHI	DRAWING STATUS: Released			TOLERANCES DO NOT APPLY DIMENSIONS ARE NOMINAL		SIZE D
DATE:	8-13-14	PRODUCTION APPROVED FOR RELEASED STATUS ONLY			ILCML1404010S0		REV A

2

3

4

SHEET 1 OF 1