

ILC16322220 REV A ECN 4195

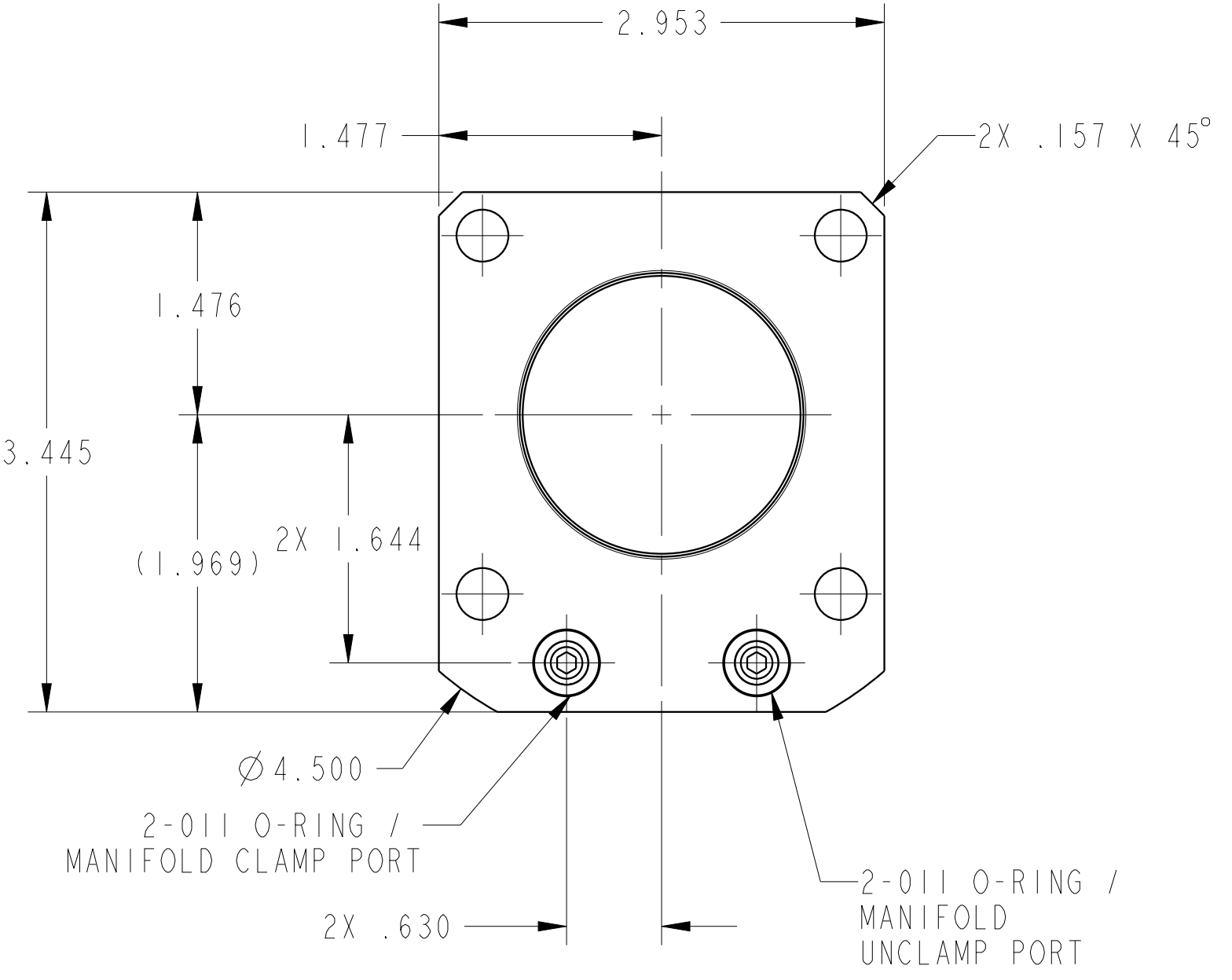

CAD CONTROL DRAWING

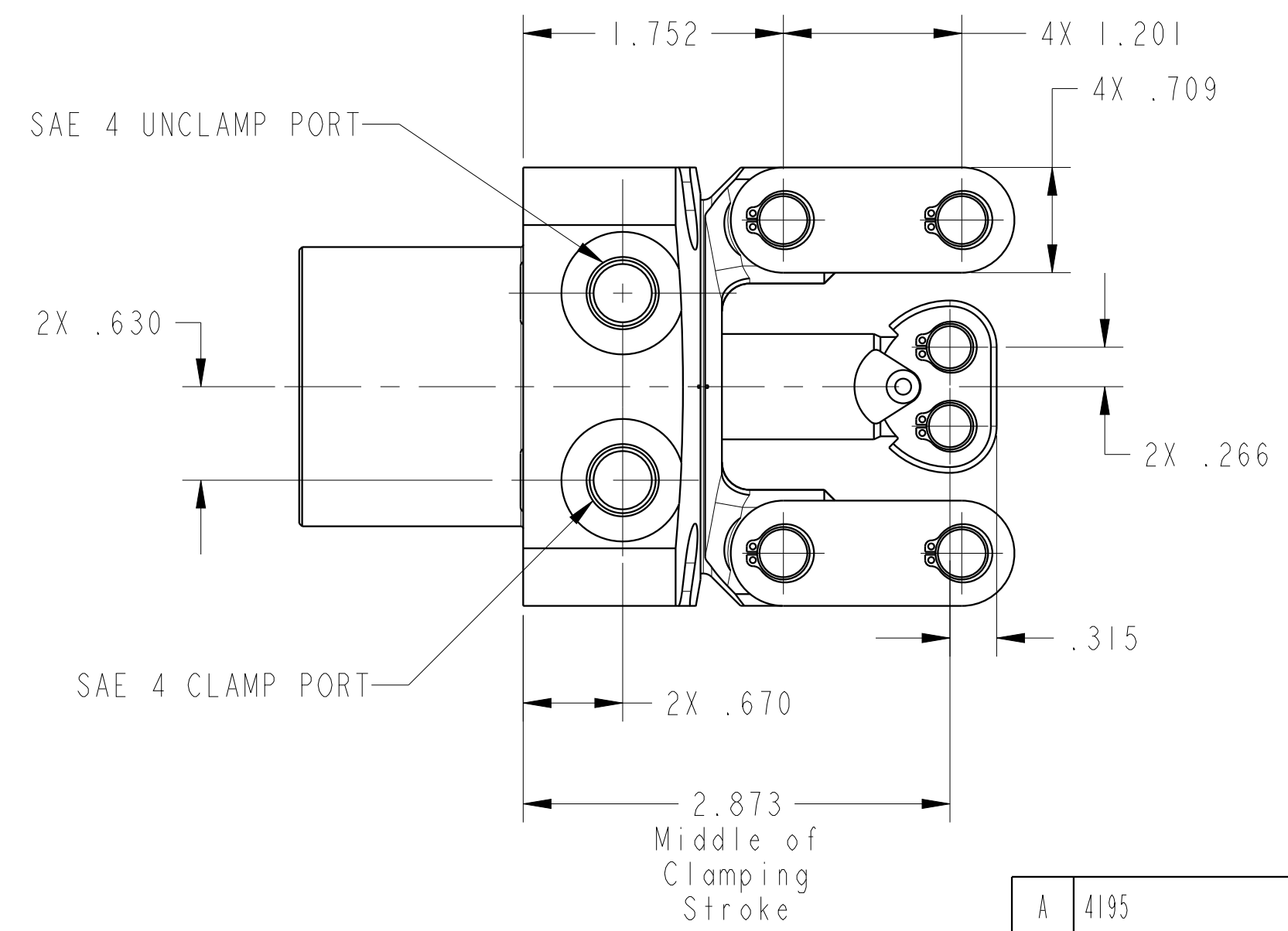
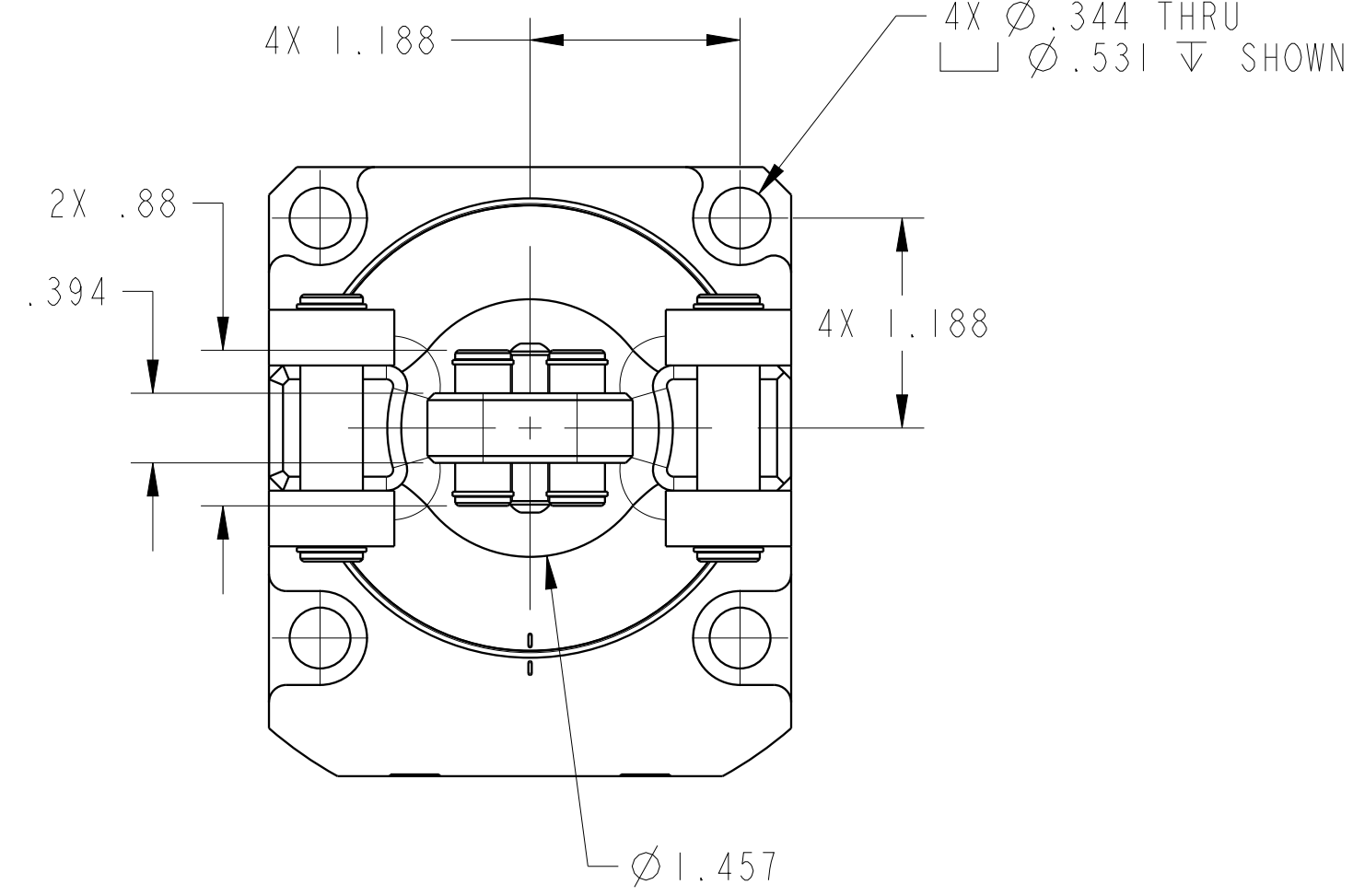
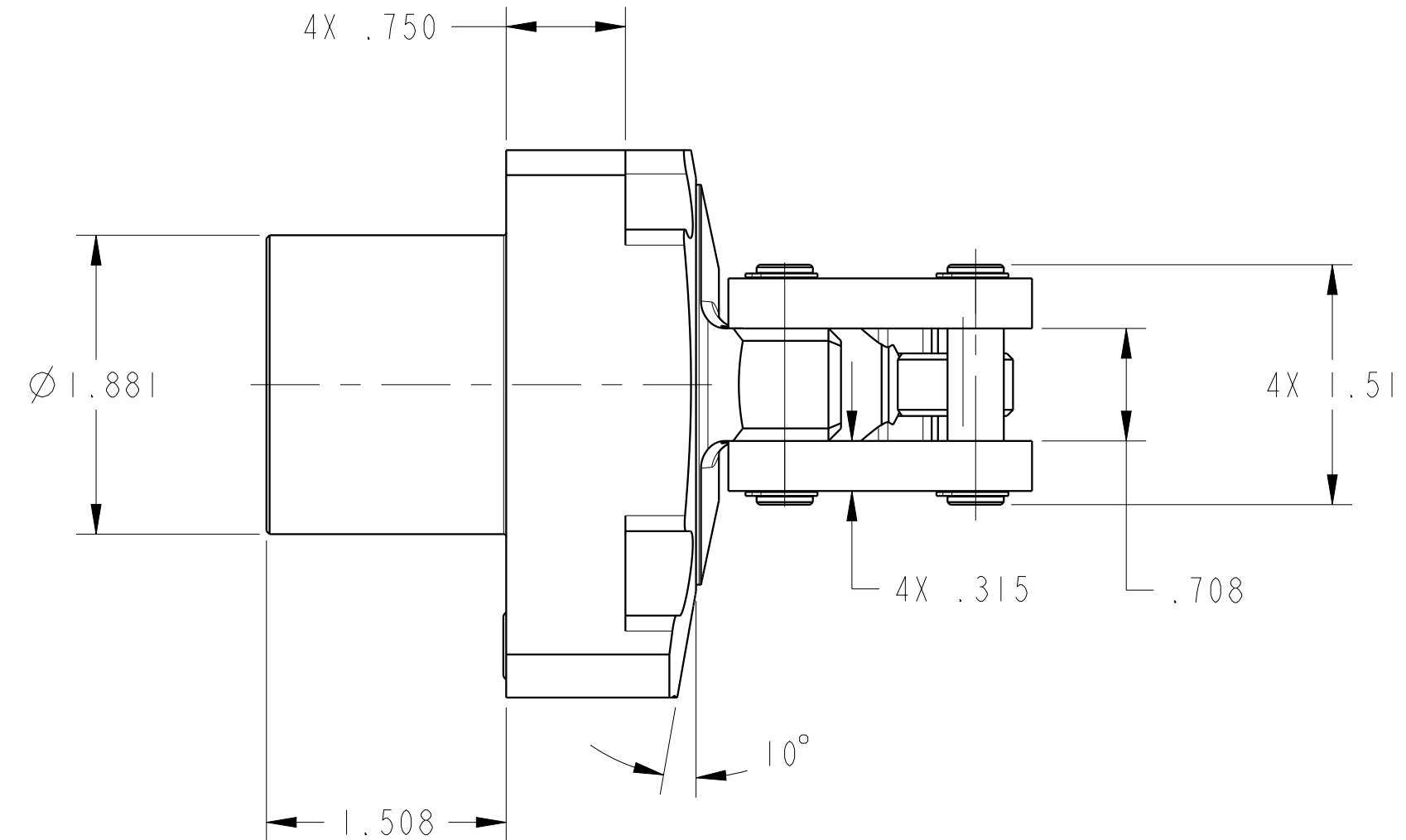
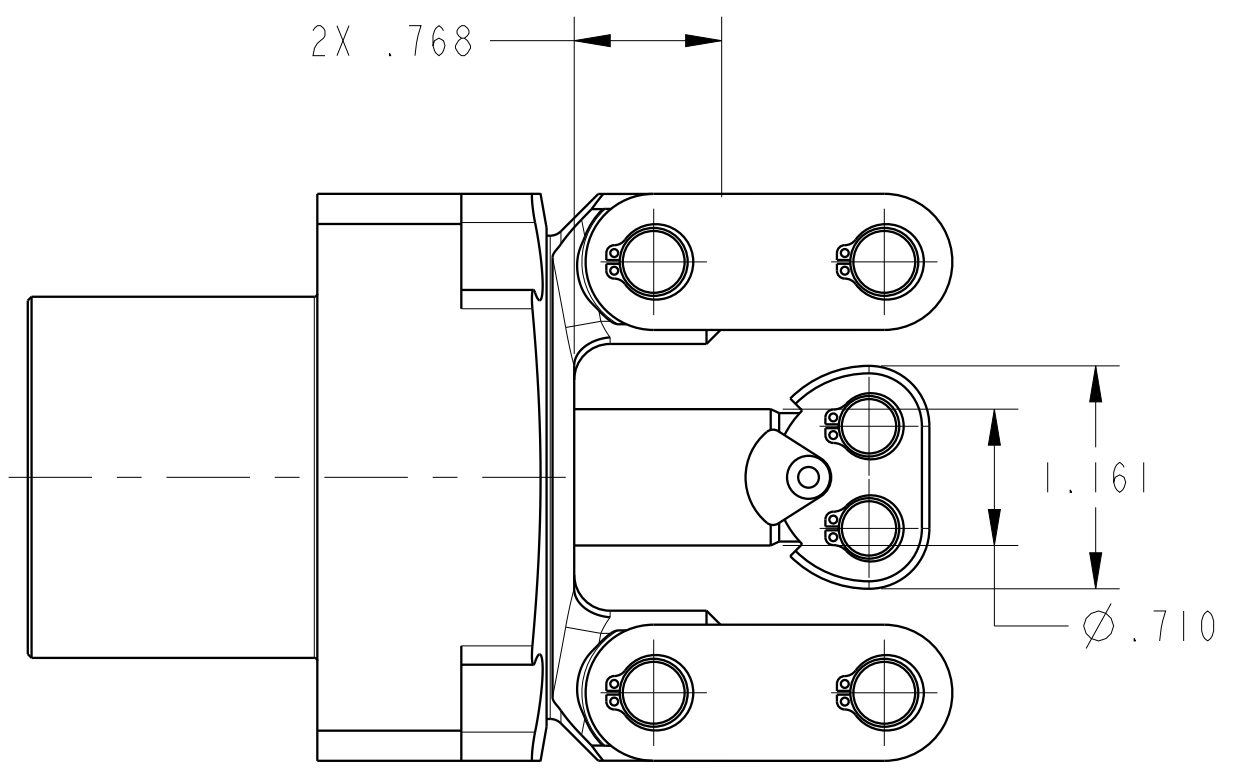

VEKTEK, INC.
1334 E. SIXTH AVE. P.O. BOX 625
EMPORIA, KS. 66801 U.S.A.

A	4195	RELEASE	A.THOMSEN	3-JUN-2020	16322220	A	LC, TL360-TWIN, DA, 26001b
REV	IN ACCORDANCE WITH ECN	EFFECTIVE DATE	REVISED BY	DATE	REFERENCE MODEL	REF REV	
DRW BY:	A.THOMSEN	DRAWING STATUS: Released			TOLERANCES DO NOT APPLY		SIZE
DATE:	25-MAY-2020	PRODUCTION APPROVED FOR RELEASED STATUS ONLY			DIMENSIONS ARE NOMINAL		D

ILC16322220 REV A