

ILC25110910 REV A ECN4446

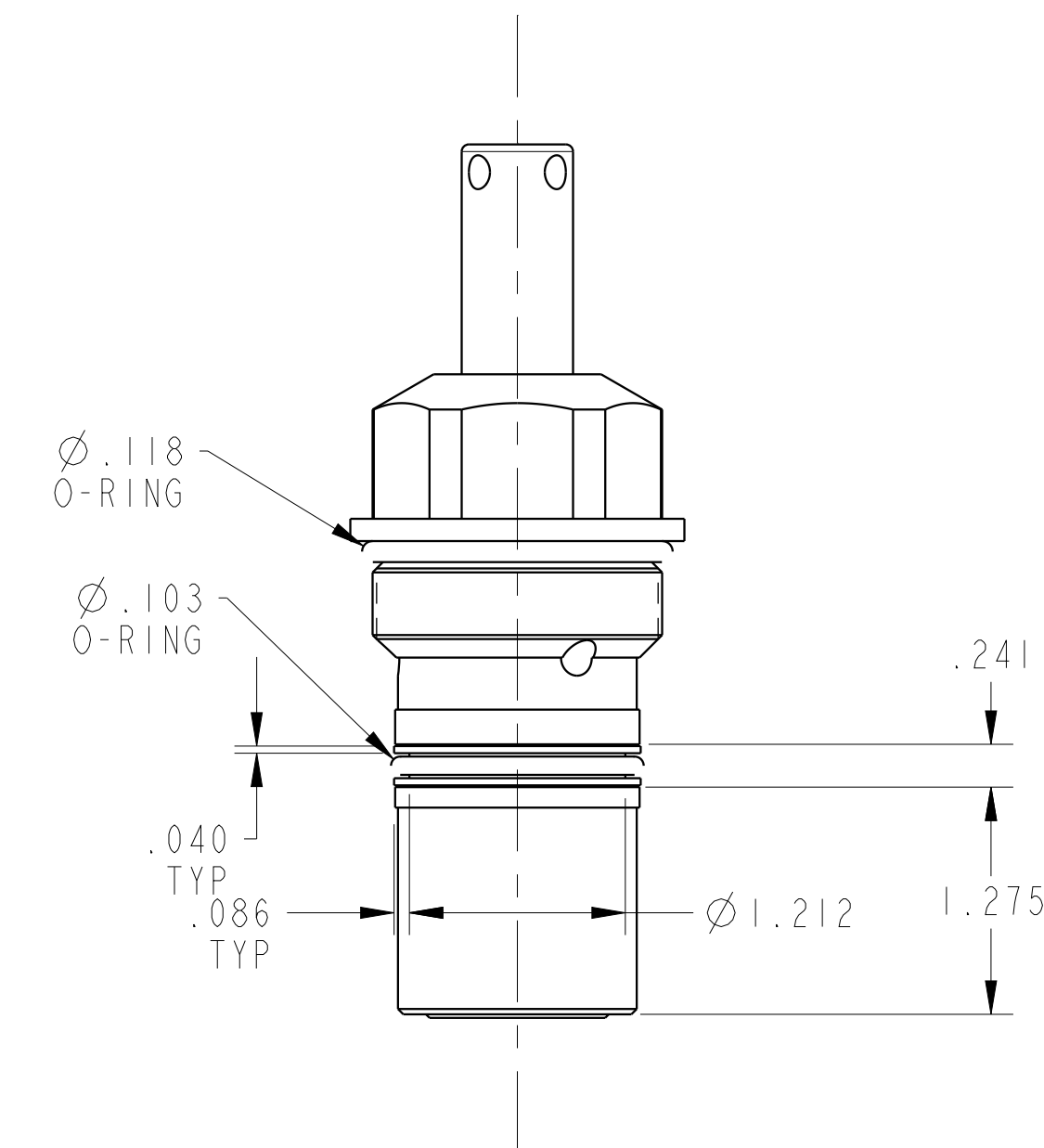

CAD CONTROL DRAWING

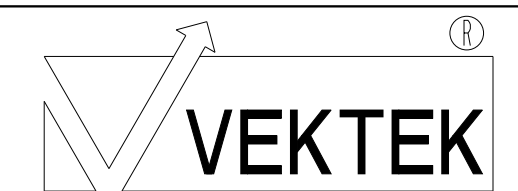

VEKTEK, INC.
1334 E. SIXTH AVE. P.O. BOX 625
EMPORIA, KS. 66801 U.S.A.

A	4446	RELEASED	ALS	5/18/21	25110910	A	CYL, PULL, CM, 1400
REV	IN ACCORDANCE WITH ECN	EFFECTIVE DATE	REVISED BY	DATE	REFERENCE MODEL	REF REV	
DRW BY:	ALS	DRAWING STATUS: Released			TOLERANCES DO NOT APPLY DIMENSIONS ARE NOMINAL		SIZE D
DATE:	5/18/21	PRODUCTION APPROVED FOR RELEASED STATUS ONLY			ILC25110910		REV A