

1

2

3

4

D

D

C

C

B

B

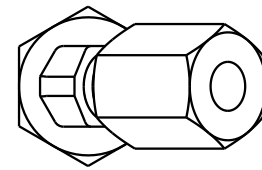

A

A

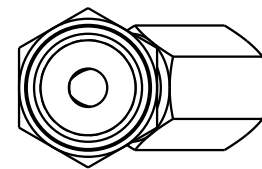
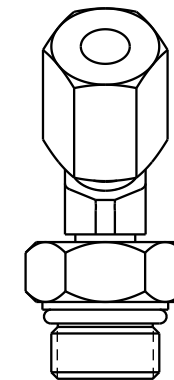
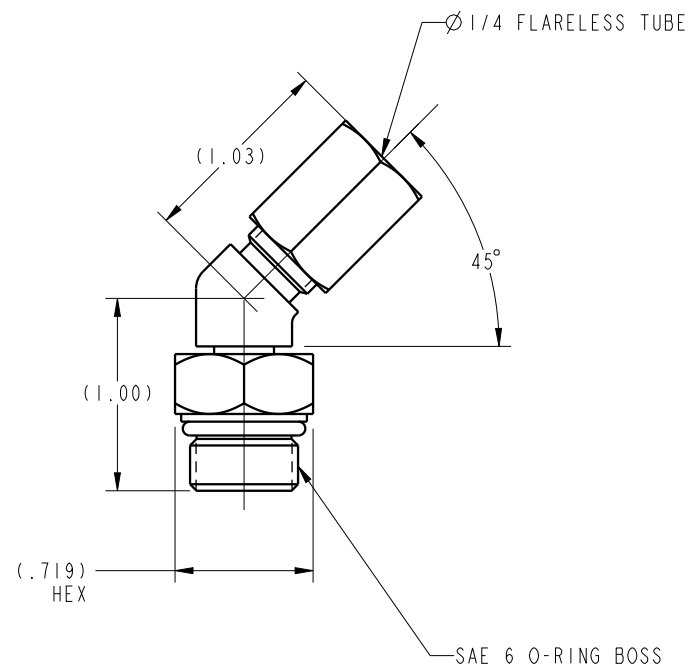
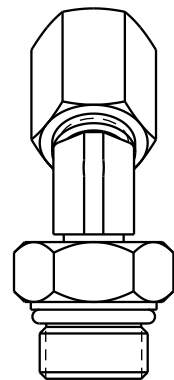

ILC30150146 REV A ECN 4756



CAD CONTROL DRAWING	 VEKTEK, INC. 1334 E. SIXTH AVE. P.O. BOX 625 EMPORIA, KS. 66801 U.S.A.	
		

A	4756	RELEASE	RLK	9/6/22	30150155	A	ELBOW, -6,M,SAE,45DEG/ADJ X 1/4,F,TUBE
REV	IN ACCORDANCE WITH ECN	EFFECTIVE DATE	REVISED BY	DATE	REFERENCE MODEL	REF REV	
DRW BY:	RLK	DRAWING STATUS: Released			TOLERANCES DO NOT APPLY		SIZE
DATE:	9/6/22	PRODUCTION APPROVED FOR RELEASED STATUS ONLY			DIMENSIONS ARE NOMINAL		B
							ILC30150146 REV A FORM FEG036, Rev. B

SHEET 1 OF 1