

ILC31124124 REV A ECN 773

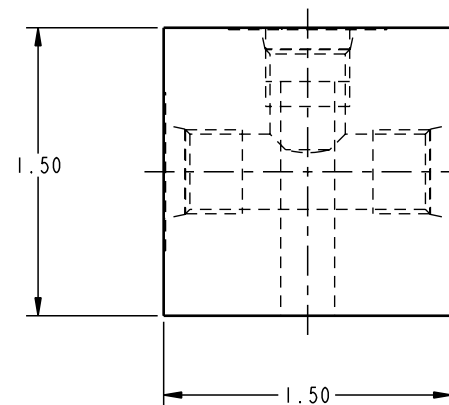

CAD CONTROL
DRAWING

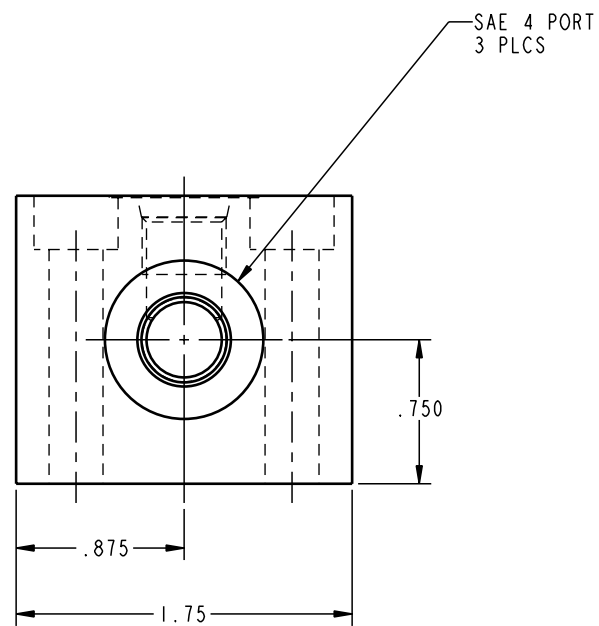
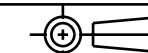

VEKTEK, INC.
1334 E. SIXTH AVE. P.O. BOX 625
EMPORIA, KS. 66801 U.S.A.

A	773	RELEASE	K. ROEMER	04-28-05	31124124	F	BLK, JCT, SAE 4-4
REV	IN ACCORDANCE WITH ECN	EFFECTIVE DATE	REVISED BY	DATE	REFERENCE MODEL	REF REV	
DRW BY:	K. ROEMER	DRAWING STATUS: Released			TOLERANCES DO NOT APPLY DIMENSIONS ARE NOMINAL		SIZE B
DATE:	11-20-02	PRODUCTION APPROVED FOR RELEASED STATUS ONLY			ILC31124124		REV A

FORM FEG036, Rev. A

SHEET 1 OF 1