

ILC55022417 REV C ECN2933

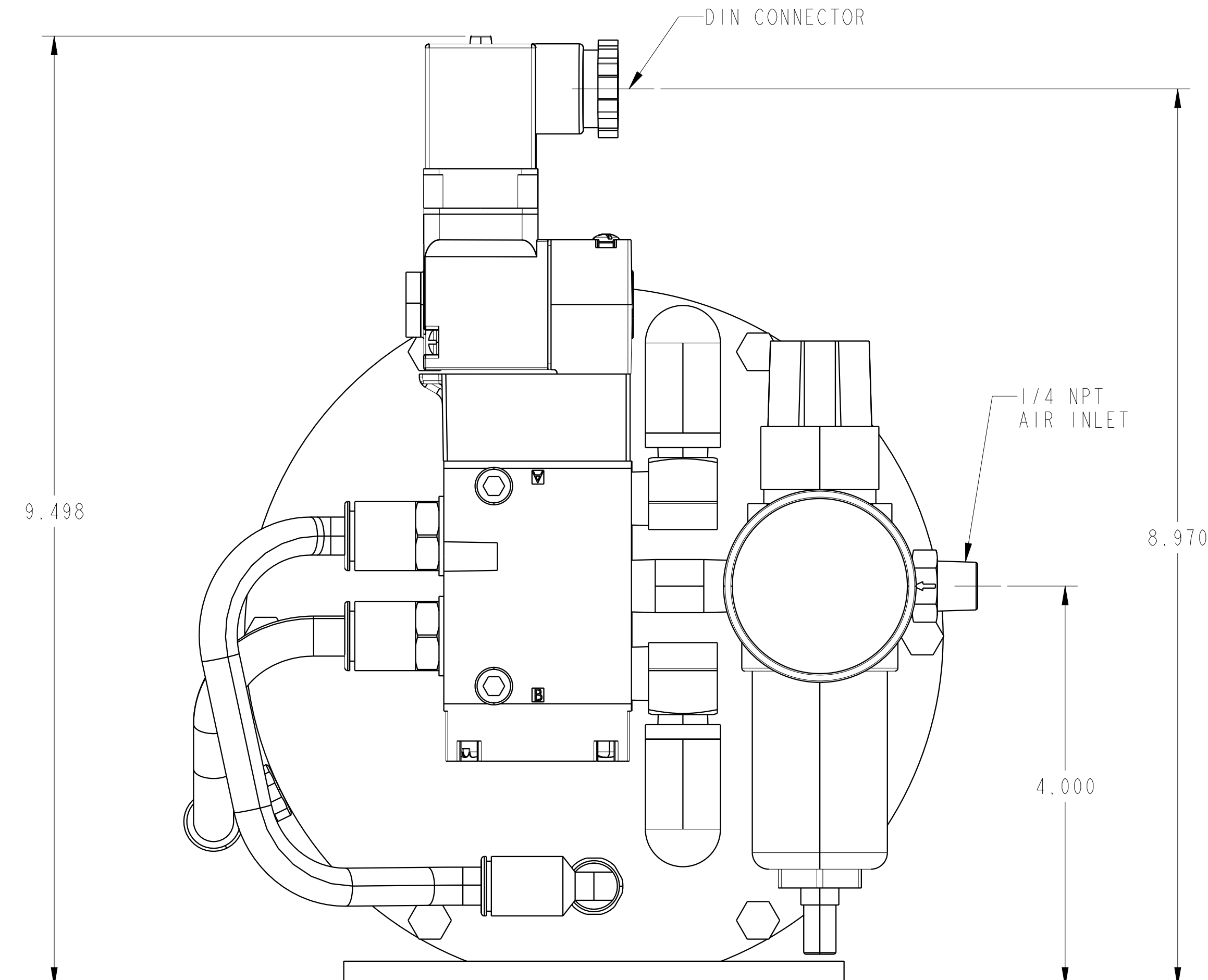
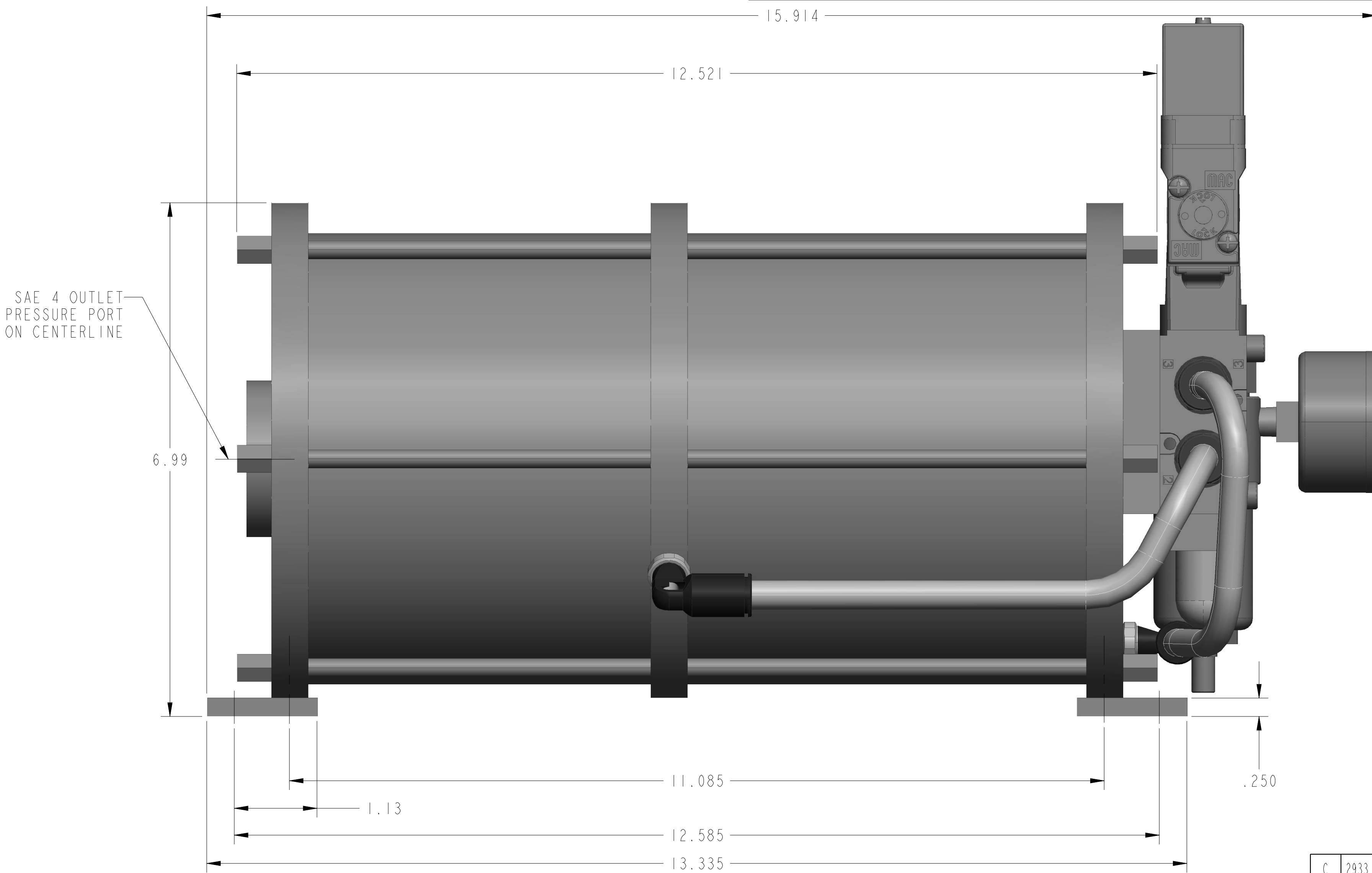
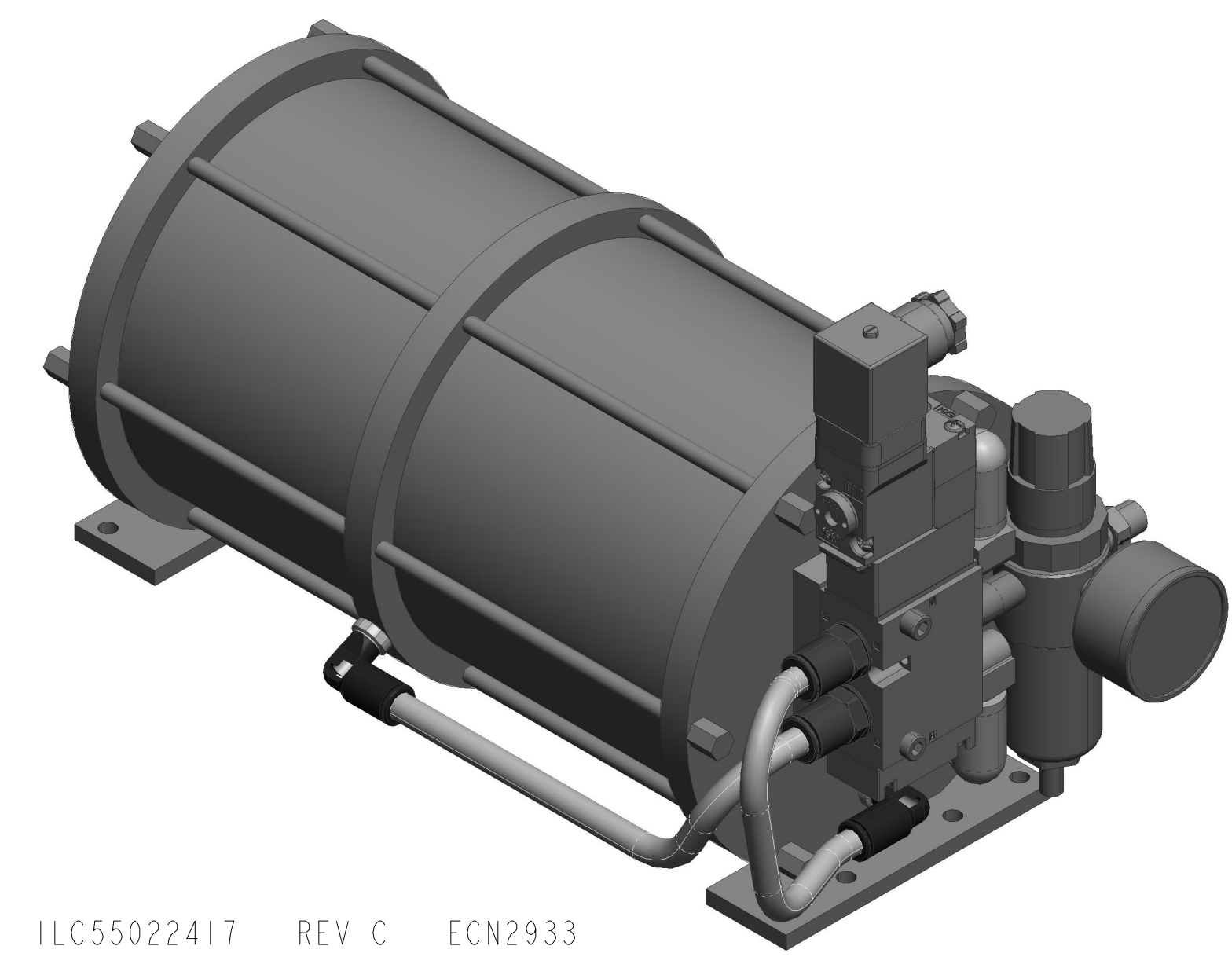

CAD CONTROL DRAWING		
	VEKTEK, INC. 1334 E. SIXTH AVE. P.O. BOX 625 EMPORIA, KS. 66801 U.S.A.	

C	2933	RELEASE	Two	11/12/15	55022417	H	BOOSTER, 54:1, 115V
REV	IN ACCORDANCE WITH ECN	EFFECTIVE DATE	REVISED BY	DATE	REFERENCE MODEL	REF REV	*****
DRW BY:	DRAWING STATUS: Released				TOLERANCES DO NOT APPLY		SIZE
DATE:	PRODUCTION APPROVED FOR RELEASED STATUS ONLY				DIMENSIONS ARE NOMINAL		D
							ILC55022417 REV C