

ILC66091204 REV A ECN 2960

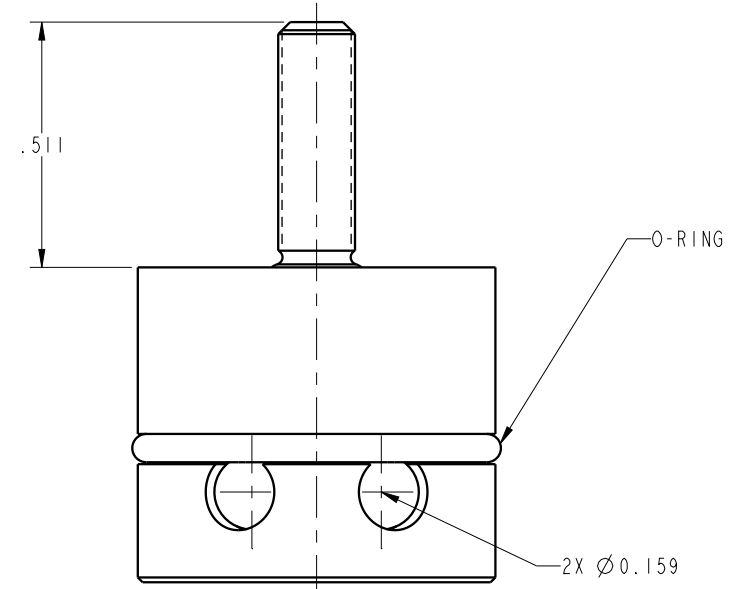
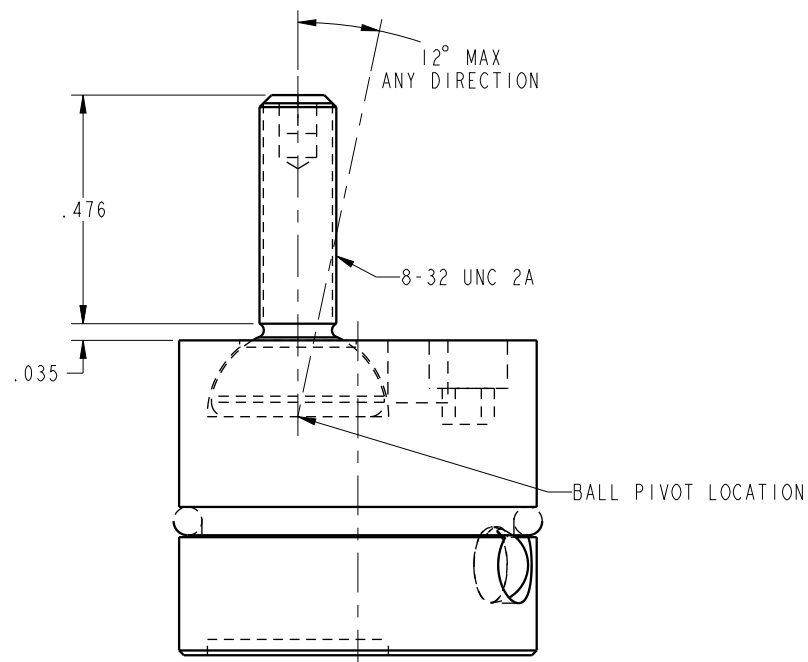

CAD CONTROL DRAWING	

A	2960	RELEASE	MAJ	1/21/16	66091204	A	ASSY, DURA PIN, 12, XHVV
REV	IN ACCORDANCE WITH ECN	EFFECTIVE DATE	REVISED BY	DATE	REFERENCE MODEL	REF REV	*****
DRW BY: MAJ	DRAWING STATUS: <b>Released</b>				TOLERANCES DO NOT APPLY DIMENSIONS ARE NOMINAL		SIZE B
DATE: 1-21-16	PRODUCTION APPROVED FOR RELEASED STATUS ONLY						ILC66091204 REV A

FORM FEG036, Rev. B

SHEET 1 OF 1