

1

2

3

4

D

D

C

C

B

B

A

A

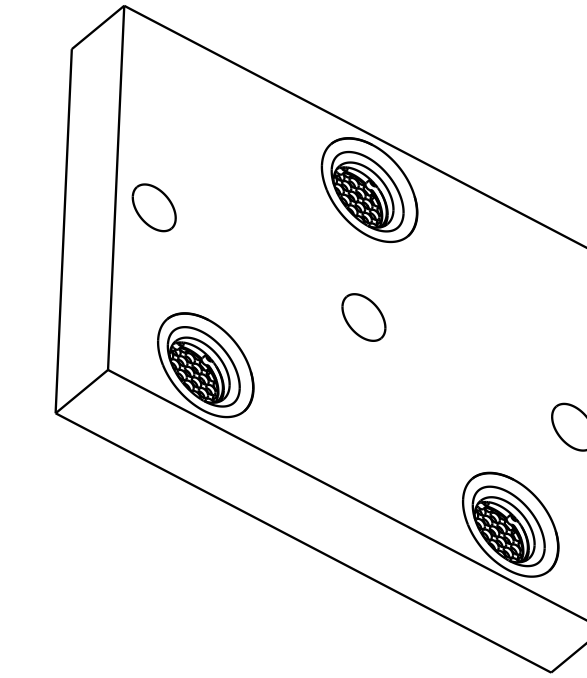
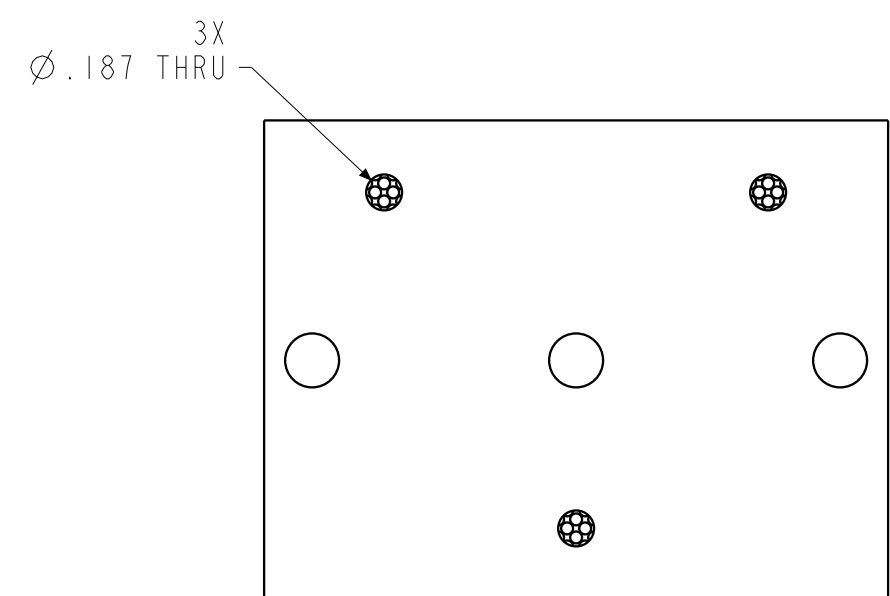
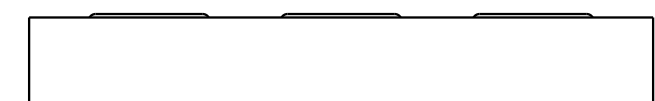
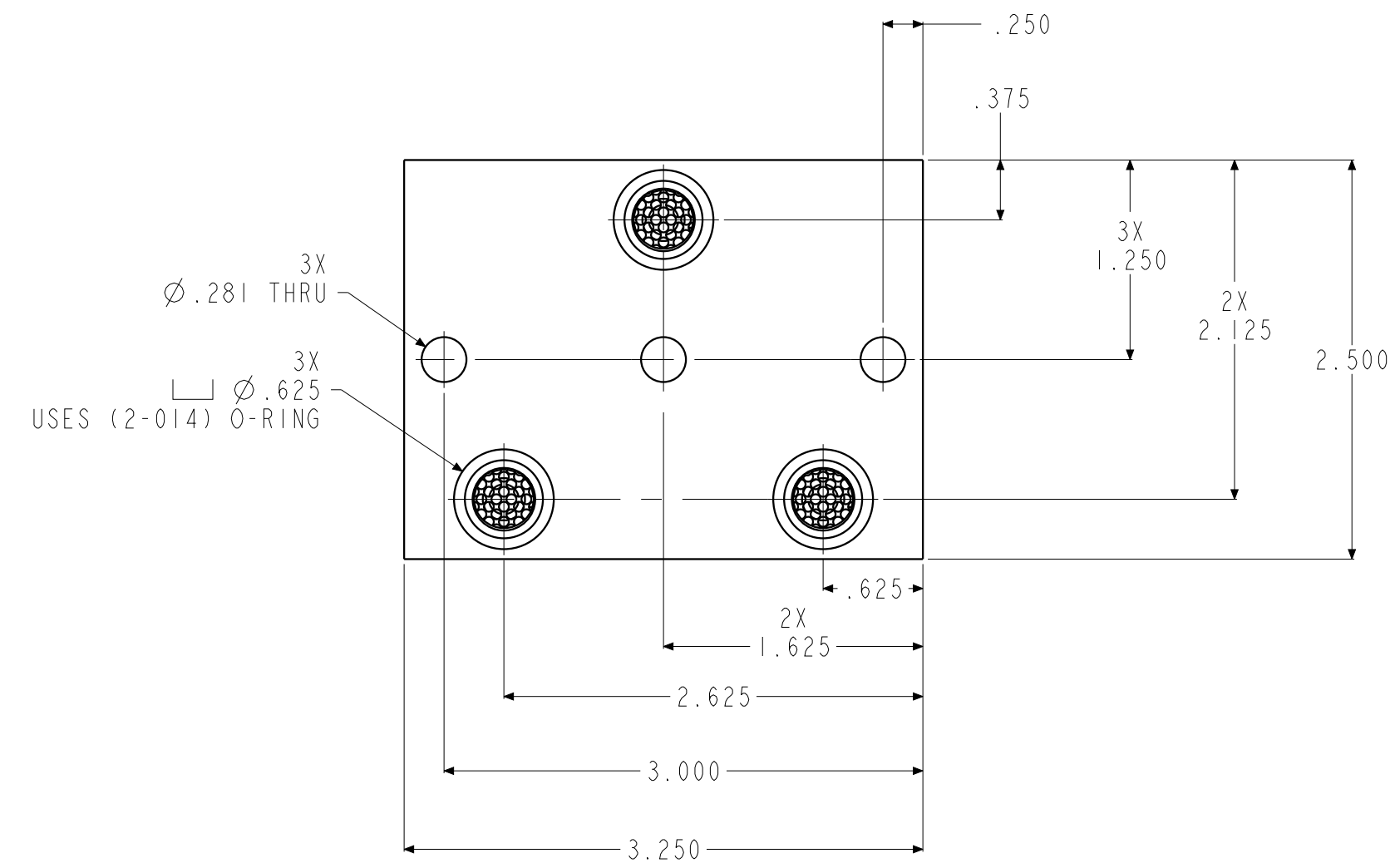
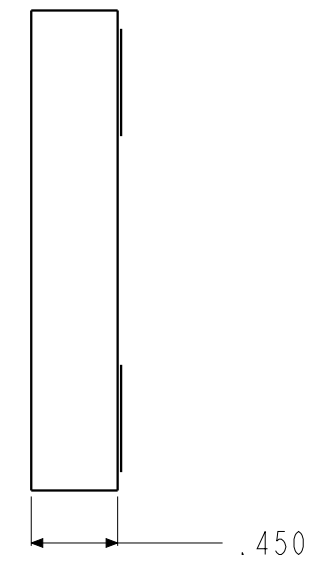

ILC70842001 REV A ECN 3538  
SCALE 1.000

CAD CONTROL  
DRAWING

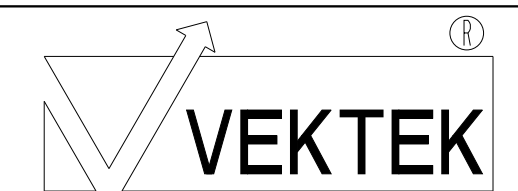

VEKTEK, INC.  
1334 E. SIXTH AVE. P.O. BOX 625  
EMPORIA, KS. 66801 U.S.A.

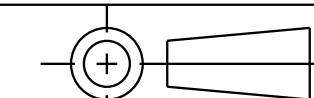

A	3538	RELEASE	JDW	08/07/18	70842001	A	ASSY, PLATE, FILTERED, SEQ-PRV
REV	IN ACCORDANCE WITH ECN	EFFECTIVE DATE	REVISED BY	DATE	REFERENCE MODEL	REF REV	
DRW BY:	JDW	DRAWING STATUS: Released			TOLERANCES DO NOT APPLY		SIZE
DATE:	08/07/18	PRODUCTION APPROVED FOR RELEASED STATUS ONLY			DIMENSIONS ARE NOMINAL		D
					ILC70842001		REV A

2

3

4

SHEET 1 OF 1