

ILCVG11A43000 REV C ECN 4410  
SCALE .375

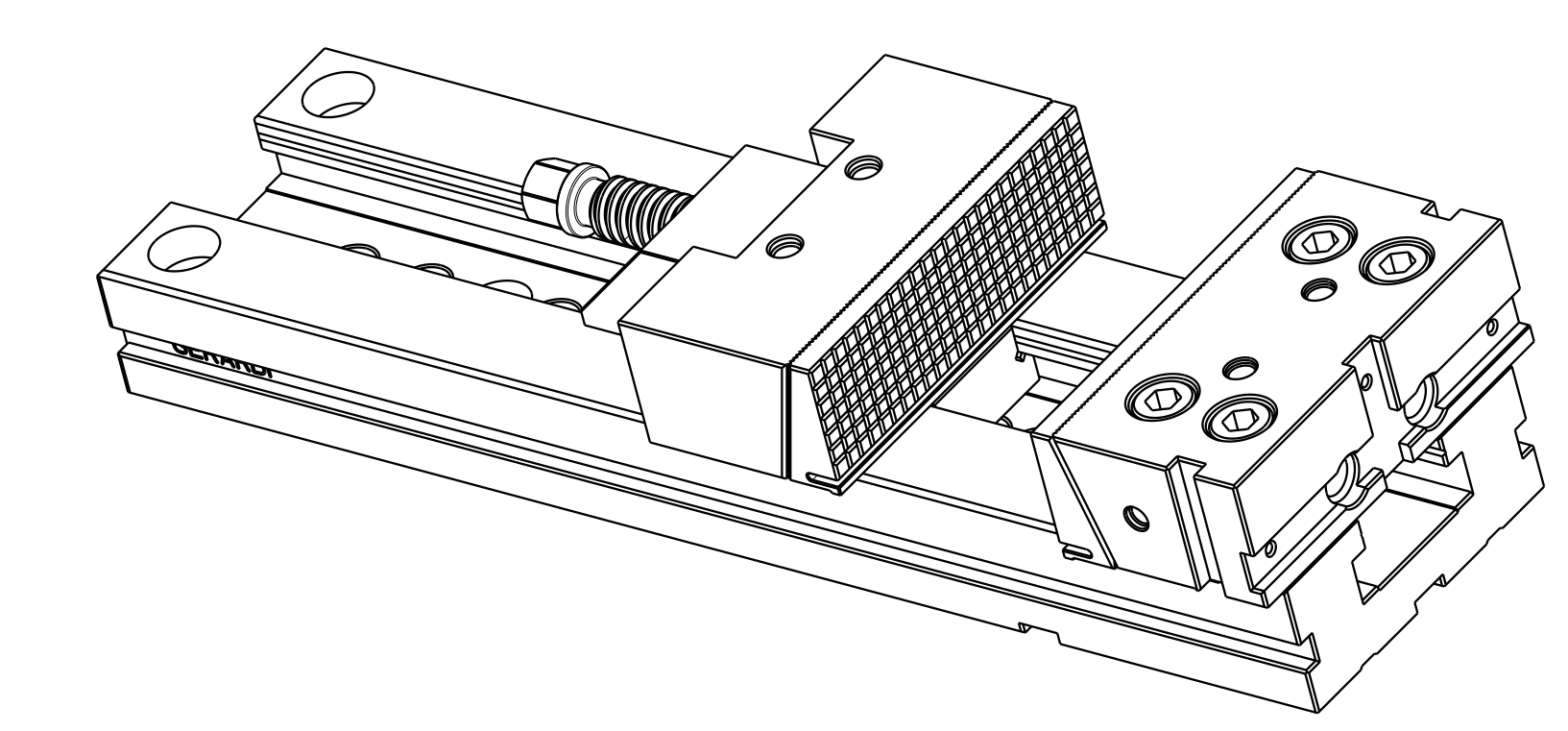
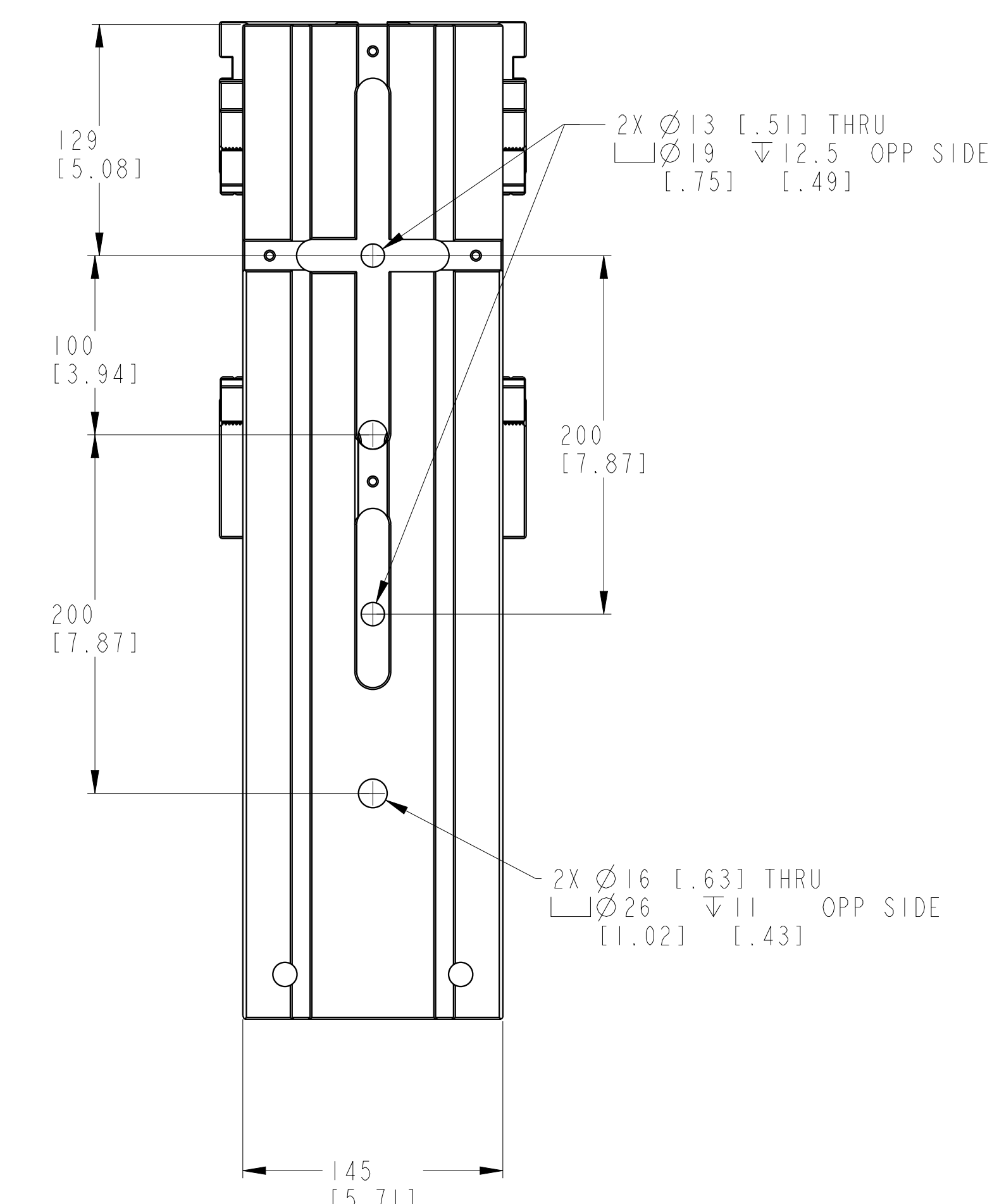
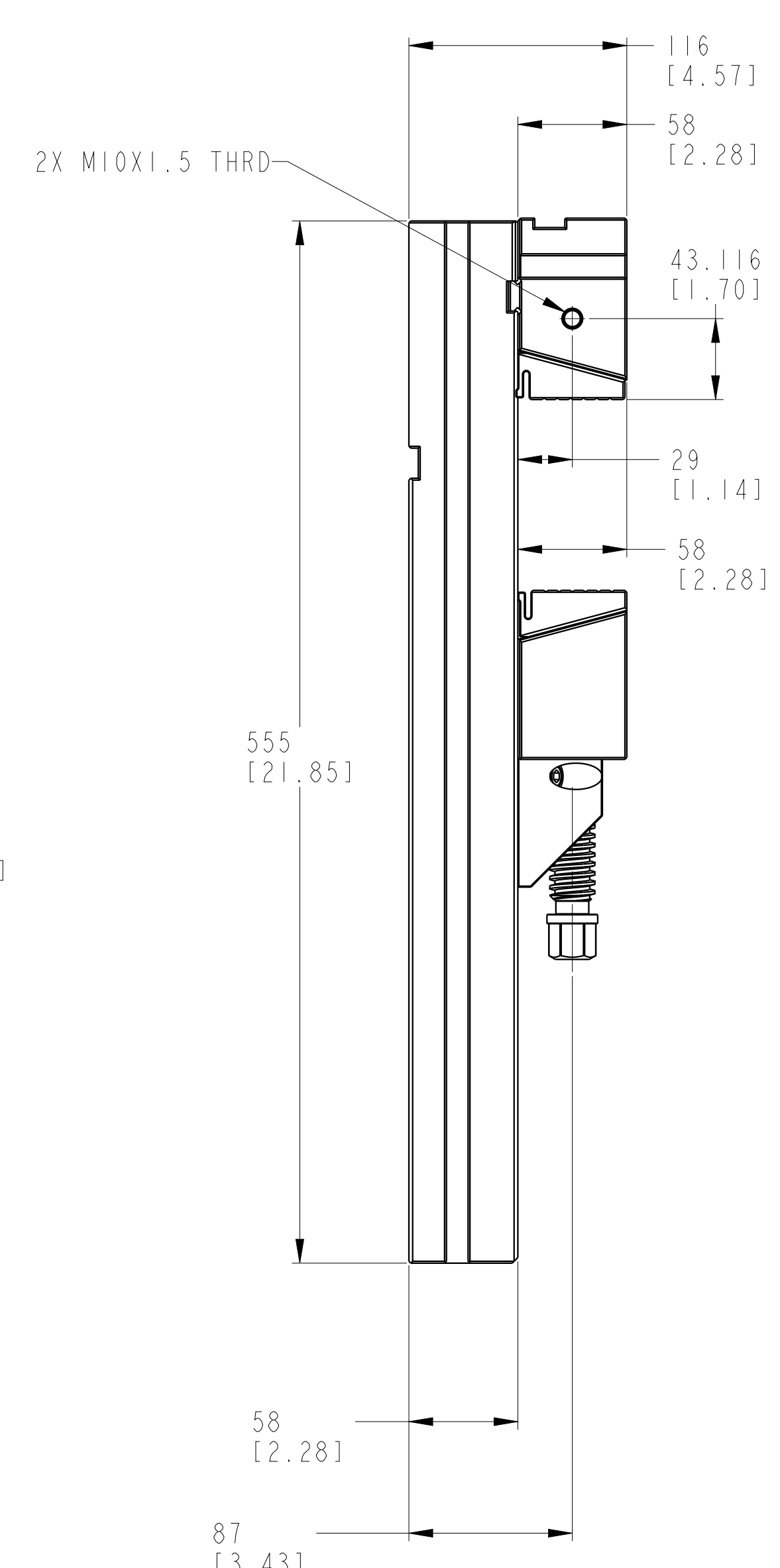

CAD CONTROL DRAWING		
	VEKTEK, INC. 1334 E. SIXTH AVE. P.O. BOX 625 EMPORIA, KS. 66801 U.S.A.	

C	4410	RELEASE	RLK	5/26/21	VG11A43000	A	ASSY, VS, MAN, FLEX, SZ 4, 30KN, 300MM
REV	IN ACCORDANCE WITH ECN	EFFECTIVE DATE	REVISED BY	DATE	REFERENCE MODEL	REF REV	*****
DRW BY:	DLG	DRAWING STATUS: Released			TOLERANCES DO NOT APPLY	UNITS	SIZE
DATE:	5/6/19	PRODUCTION APPROVED FOR RELEASED STATUS ONLY			DIMENSIONS ARE NOMINAL	mm (inch)	D
							ILCVG11A43000
							REV C