

ILCVG11A56000 REV C ECN 4410
SCALE .250

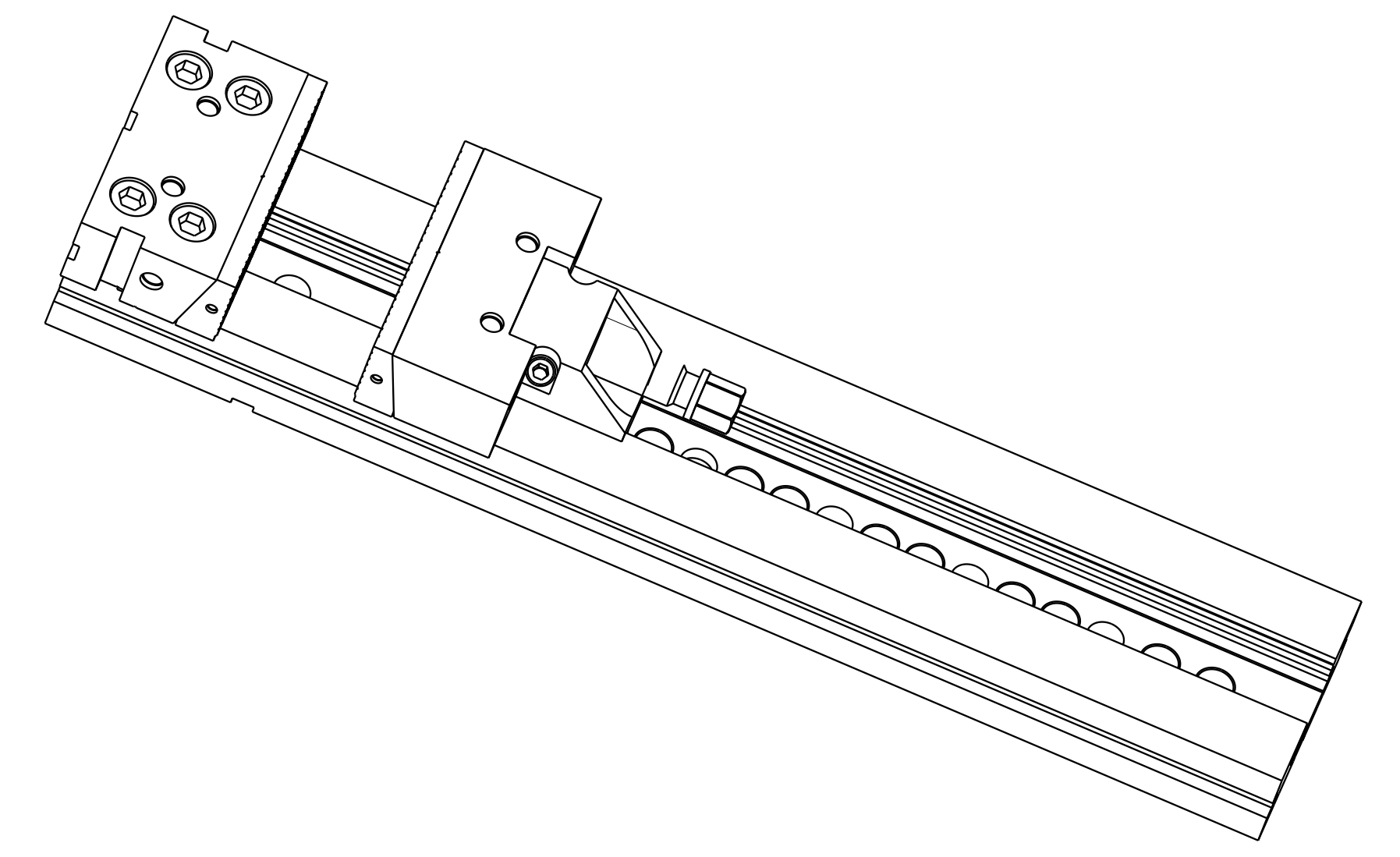
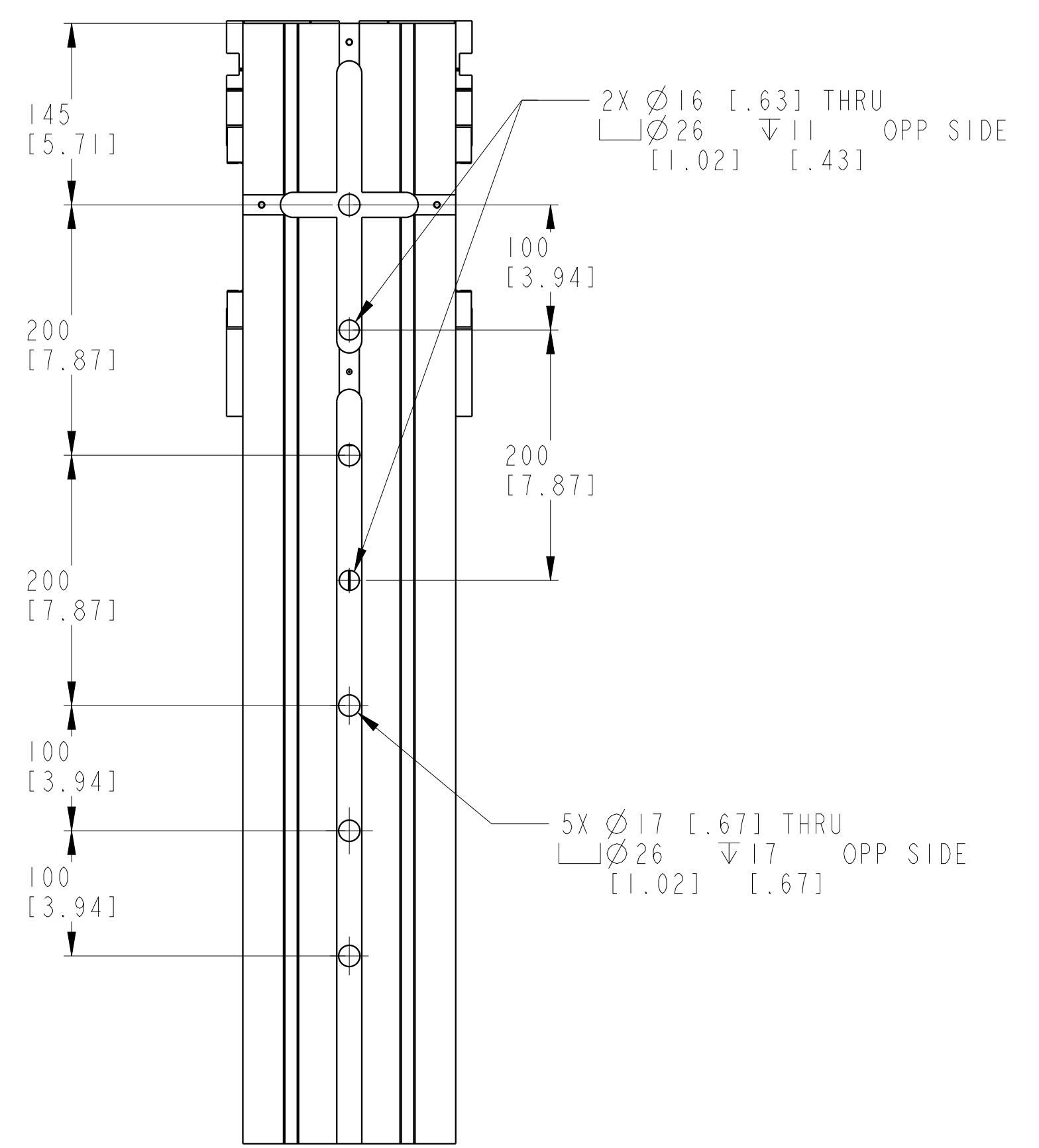
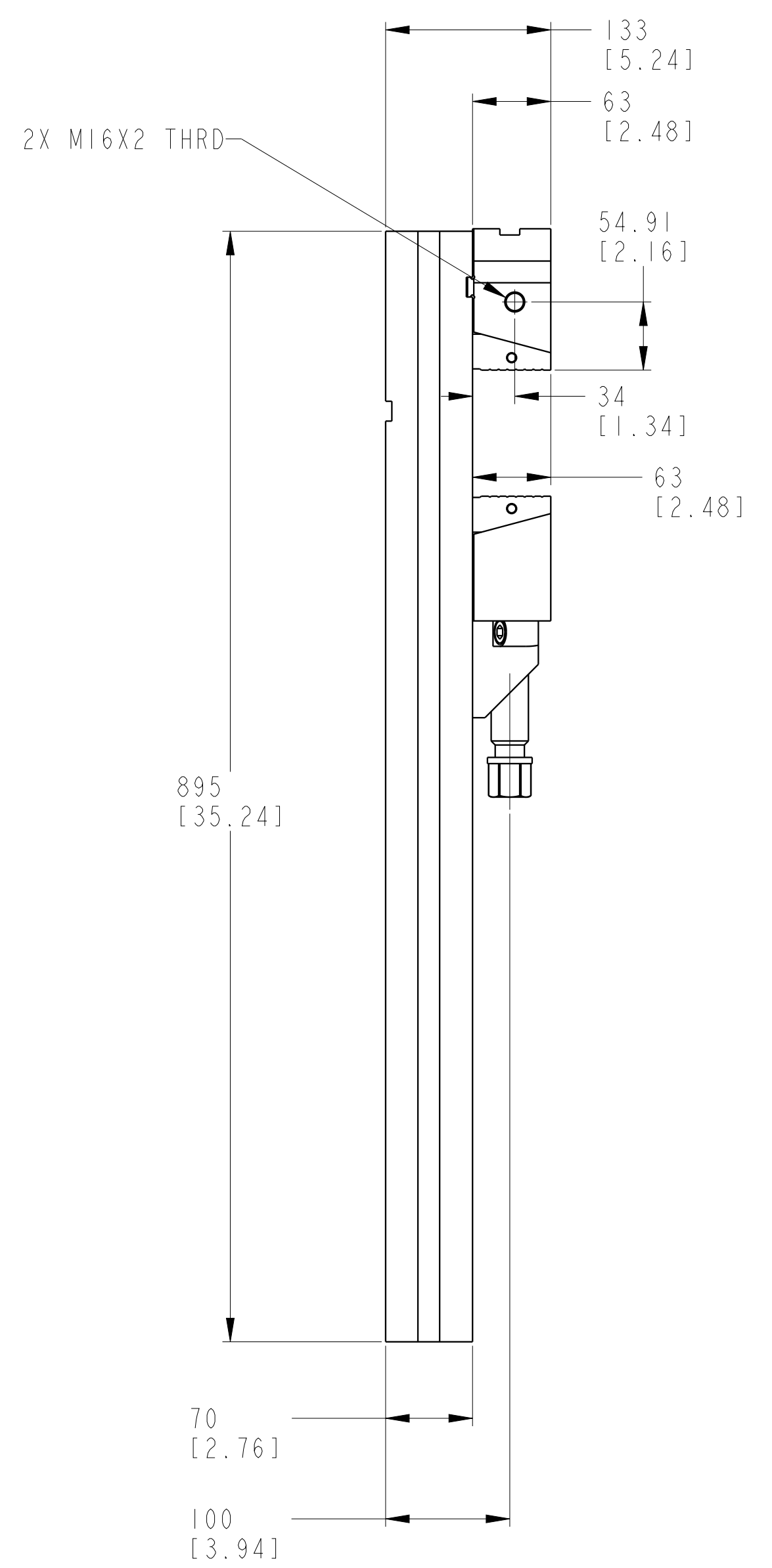

CAD CONTROL DRAWING		
	VEKTEK, INC. 1334 E. SIXTH AVE. P.O. BOX 625 EMPORIA, KS. 66801 U.S.A.	

C	4410	RELEASE	RLK	5/26/21	VG11A56000	A	ASSY, VS, MAN, FLEX, SZ 5, 40KN, 600MM
REV	IN ACCORDANCE WITH ECN	EFFECTIVE DATE	REVISED BY	DATE	REFERENCE MODEL	REF REV	*****
DRW BY:	DRAWING STATUS: Released				TOLERANCES DO NOT APPLY	UNITS	SIZE
DATE:	PRODUCTION APPROVED FOR RELEASED STATUS ONLY				DIMENSIONS ARE NOMINAL	mm (inch)	D
							ILCVG11A56000
							REV C