

ILCM-VGP-160-C1 REV A ECN5231

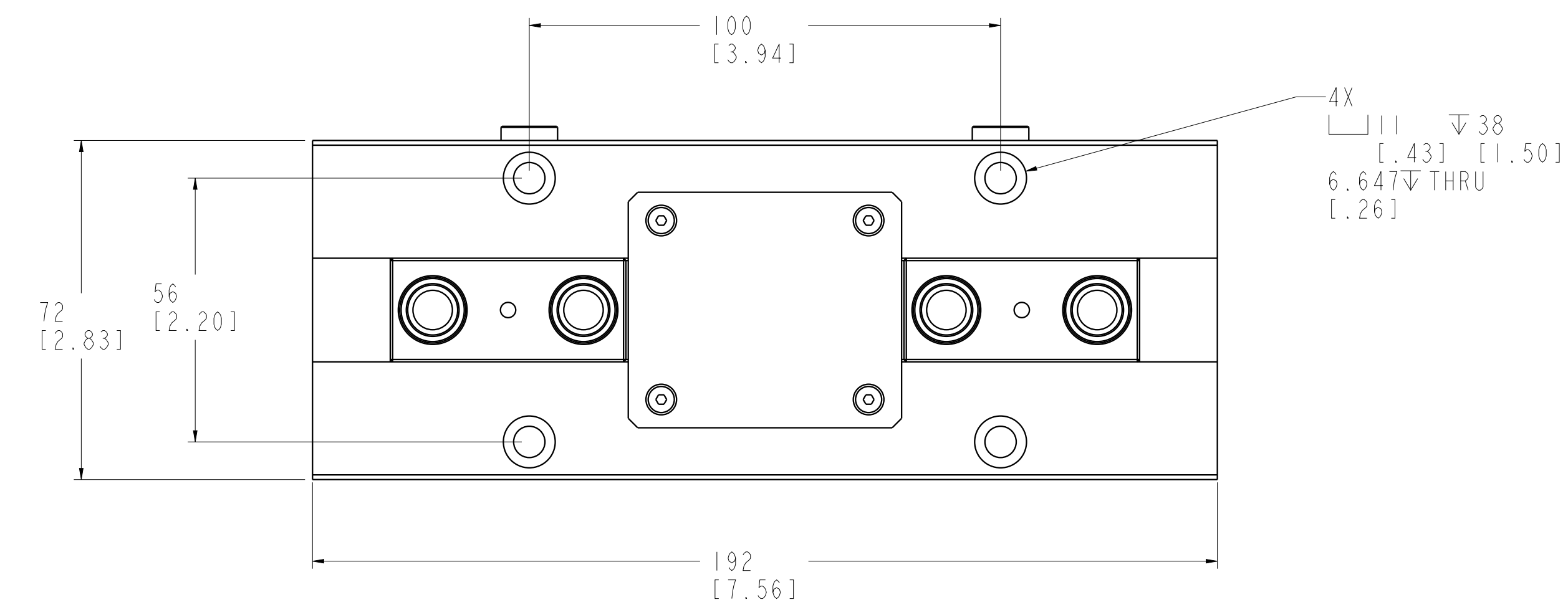
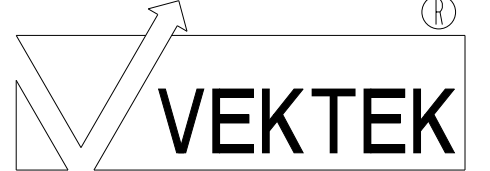

CAD CONTROL DRAWING		
	VEKTEK, INC. 1334 E. SIXTH AVE. P.O. BOX 625 EMPORIA, KS. 66801 U.S.A.	

A	5231	RELEASE	AJT	2/6/24	VGP-160-C1	A	GRIPPER, 2-JAW, PL, 160, PNEU
REV	IN ACCORDANCE WITH ECN	EFFECTIVE DATE	REVISED BY	DATE	REFERENCE MODEL	REF REV	
DRW BY:	AJT	DRAWING STATUS: Released			TOLERANCES DO NOT APPLY	UNITS	SIZE
DATE:	2/1/24	PRODUCTION APPROVED FOR RELEASED STATUS ONLY			DIMENSIONS ARE NOMINAL	mm (inch)	D
							ILCM-VGP-160-C1
							REV A