

ILCM41572107 REV A ECN 1498

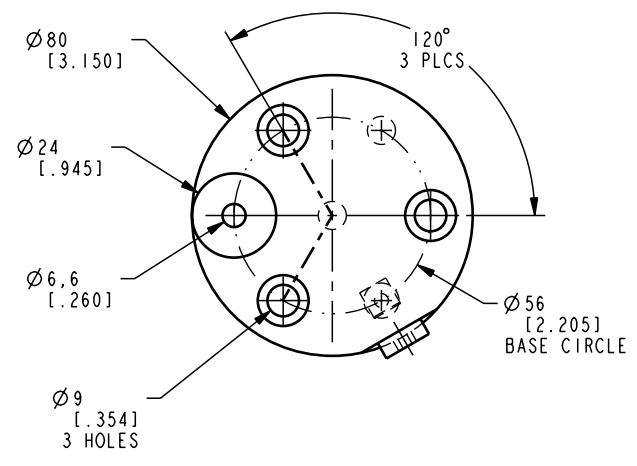
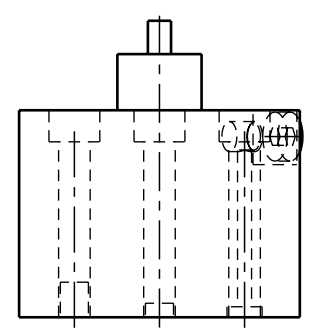
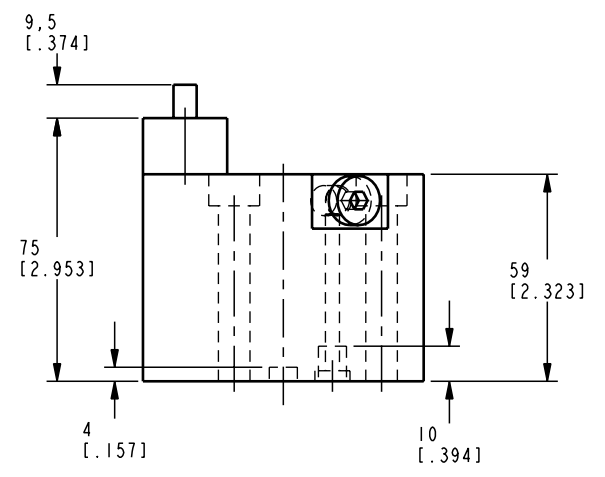
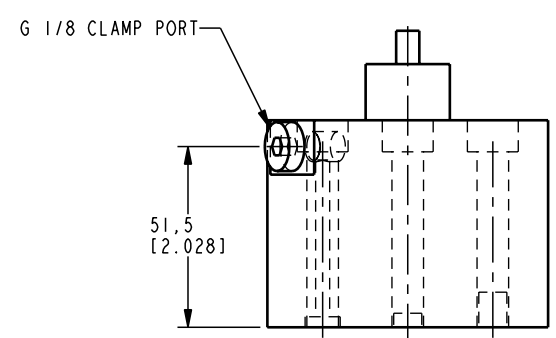

CAD CONTROL DRAWING

VEKTEK, INC.
1334 E. SIXTH AVE. P.O. BOX 625
EMPORIA, KS. 66801 U.S.A.

A	1498	RELEASE	K. ROEMER	05-10-06	41572107	A	CLAMP, PL DN, SA, 3.5 KN, 7MM, ECC	
REV	IN ACCORDANCE WITH ECN	EFFECTIVE DATE	REVISED BY	DATE	REFERENCE MODEL	REF REV	*****	
DRW BY:	K. ROEMER	DRAWING STATUS: Released			TOLERANCES DO NOT APPLY	UNITS	SIZE	
DATE:	05-10-06	PRODUCTION APPROVED FOR RELEASED STATUS ONLY			DIMENSIONS ARE NOMINAL	mm [inch]	D ILCM41572107	
							REV	A

FORM FEG036, Rev. B