

1

2

3

4

D

D

C

C

B

B

A

A

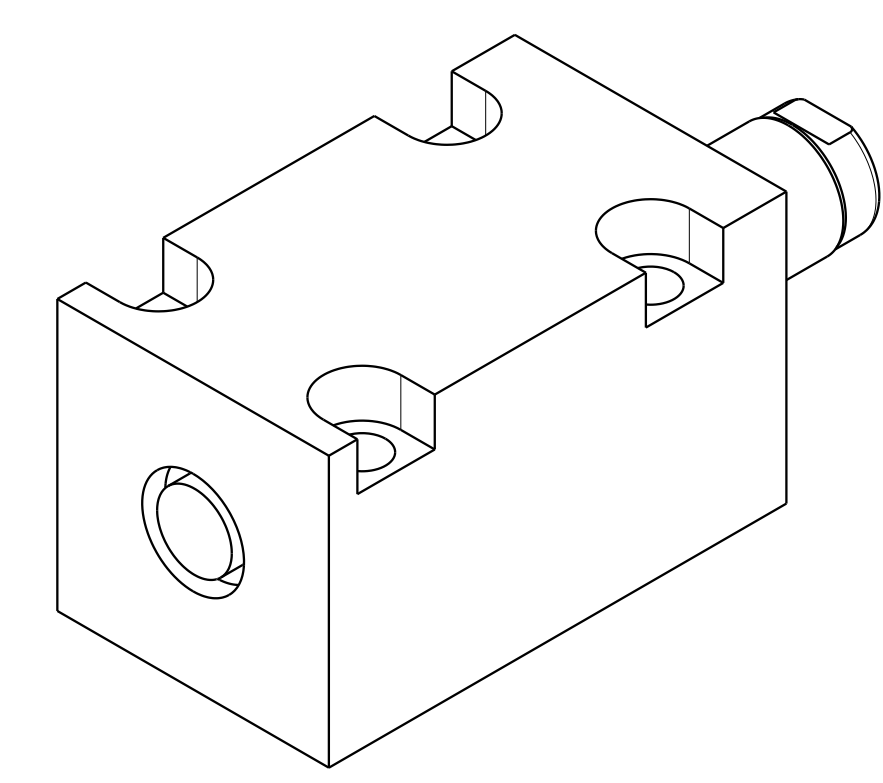
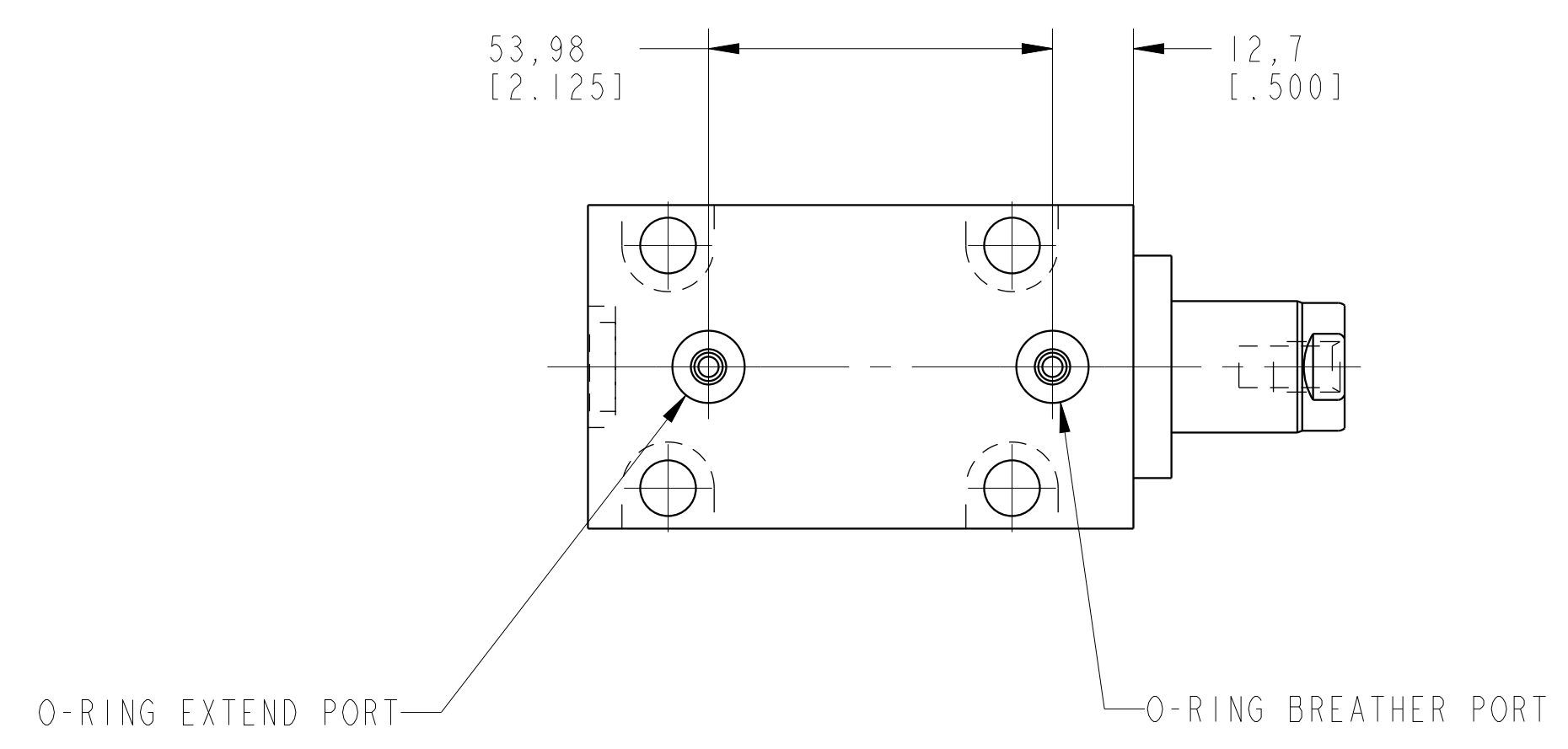

ILCM42111008 REV C ECN 3003

SCALE 1.000

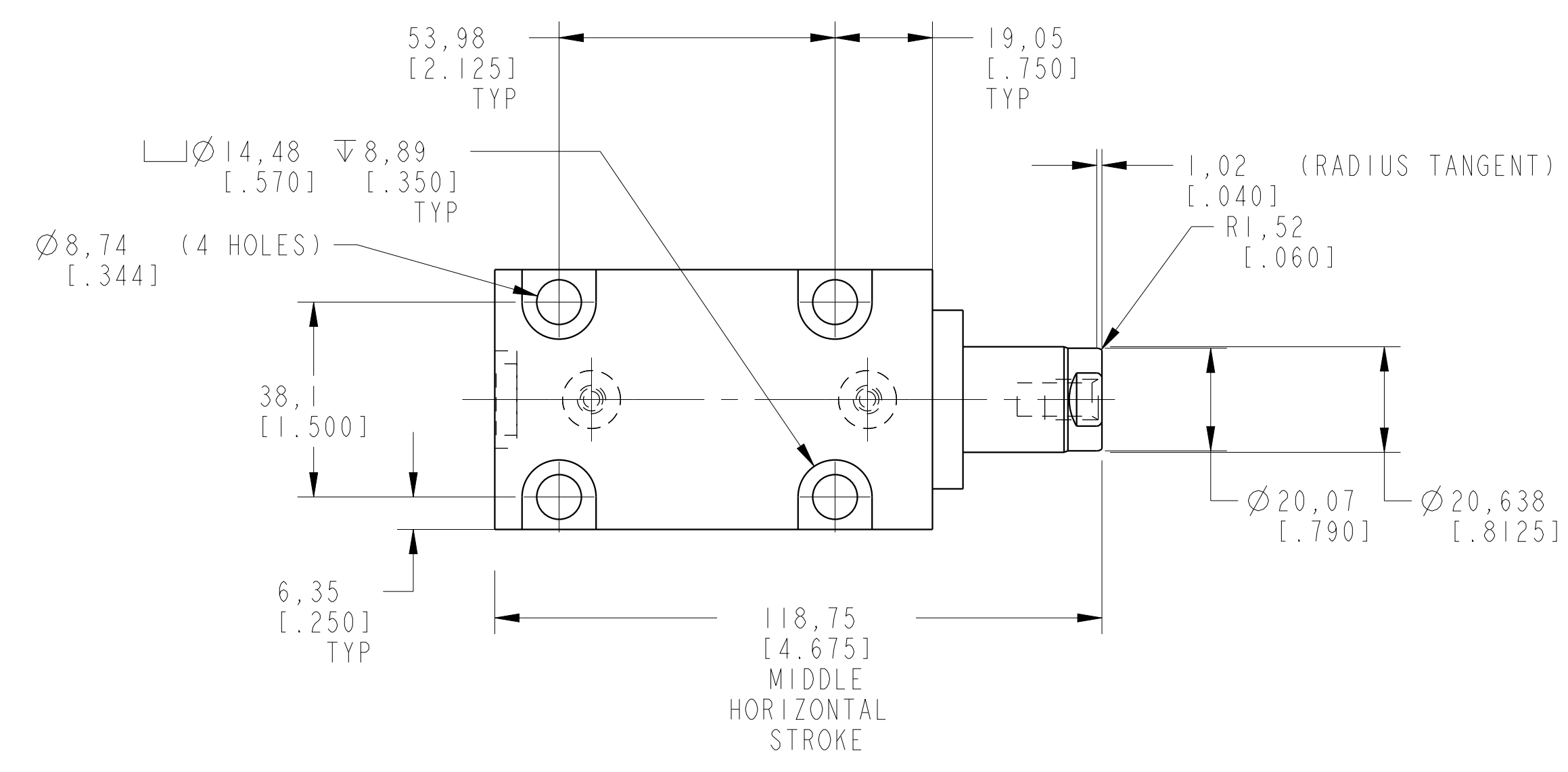
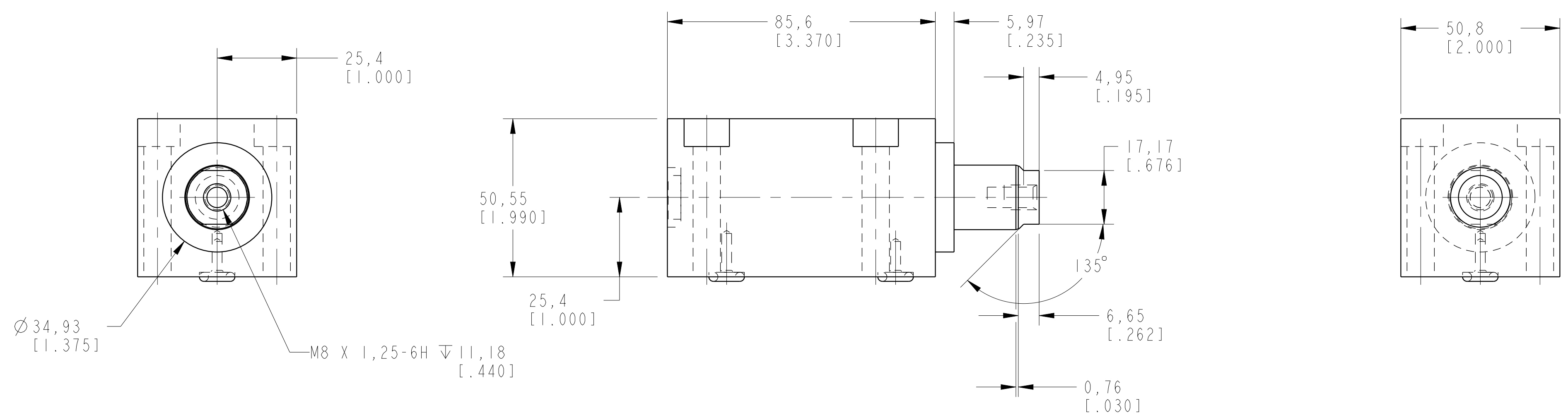

CAD CONTROL DRAWING



VEKTEK, INC.  
1334 E. SIXTH AVE. P.O. BOX 625  
EMPORIA, KS. 66801 U.S.A.

C	3003	RELEASE	MAJ	4/8/16
REV	IN ACCORDANCE WITH ECN	EFFECTIVE DATE	REVISED BY	DATE
DRW BY:	G. ROMINE	DRAWING STATUS: <b>Released</b>		
DATE:	02/29/08	PRODUCTION APPROVED FOR RELEASED STATUS ONLY		

42111008	A	CYL, BB, MM, 17, 8KN, 38, 1STRK, SA
TOLERANCES DO NOT APPLY DIMENSIONS ARE NOMINAL	UNITS mm (inch)	SIZE D

ILCM42111008	REV C
--------------	----------