

I LCM42114300 REV A ECN 3136

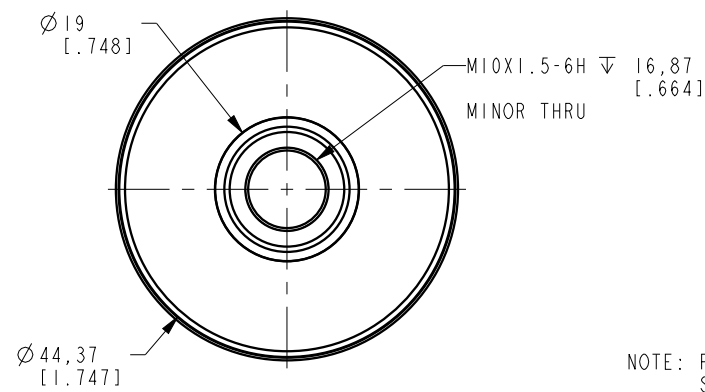
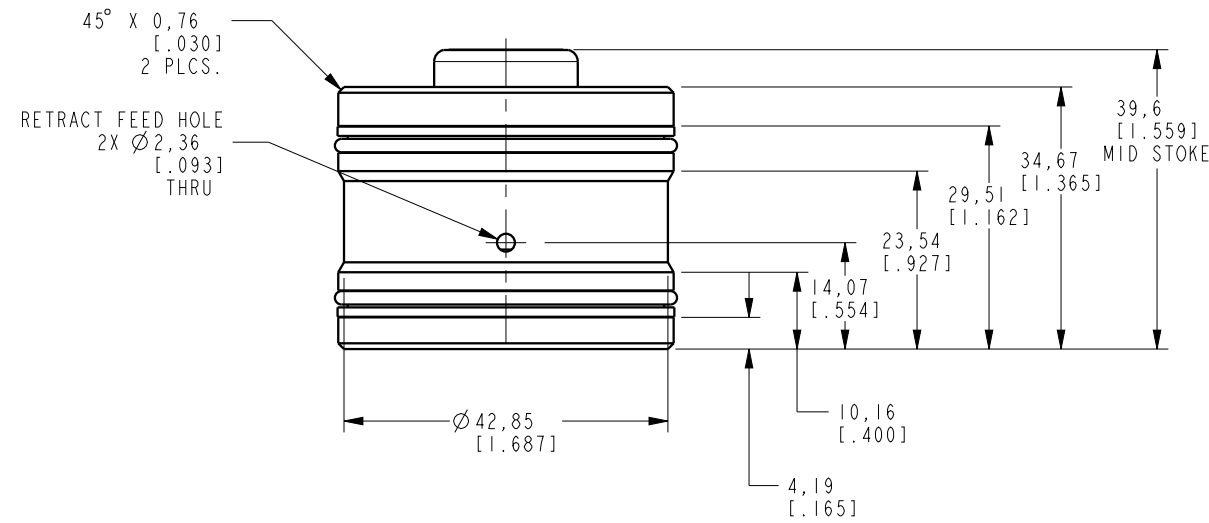

NOTE: RETURN SPRING INCLUDED WITH CYLINDER.
SPRING OMITTED FOR CLARITY

CAD CONTROL DRAWING			
		VEKTEK, INC. 1334 E. SIXTH AVE. P.O. BOX 625 EMPORIA, KS. 66801 U.S.A.	

A	3136	RELEASE	DKC	11/9/16	42114300	A	CYL, CM, PULL, 23.1kN
REV	IN ACCORDANCE WITH ECN	EFFECTIVE DATE	REVISED BY	DATE	REFERENCE MODEL	REF REV	M10X1.5 THREAD
DRW BY:	DKC	DRAWING STATUS: Released			TOLERANCES DO NOT APPLY	UNITS	SIZE
DATE:	11/1/16	PRODUCTION APPROVED FOR RELEASED STATUS ONLY			DIMENSIONS ARE NOMINAL	mm [inch]	B
					I LCM42114300		REV A

FORM FEG036, Rev. C

SHEET 1 OF 1