

ILCM91600403 REV B ECN 1433

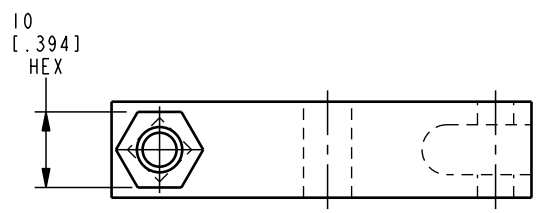
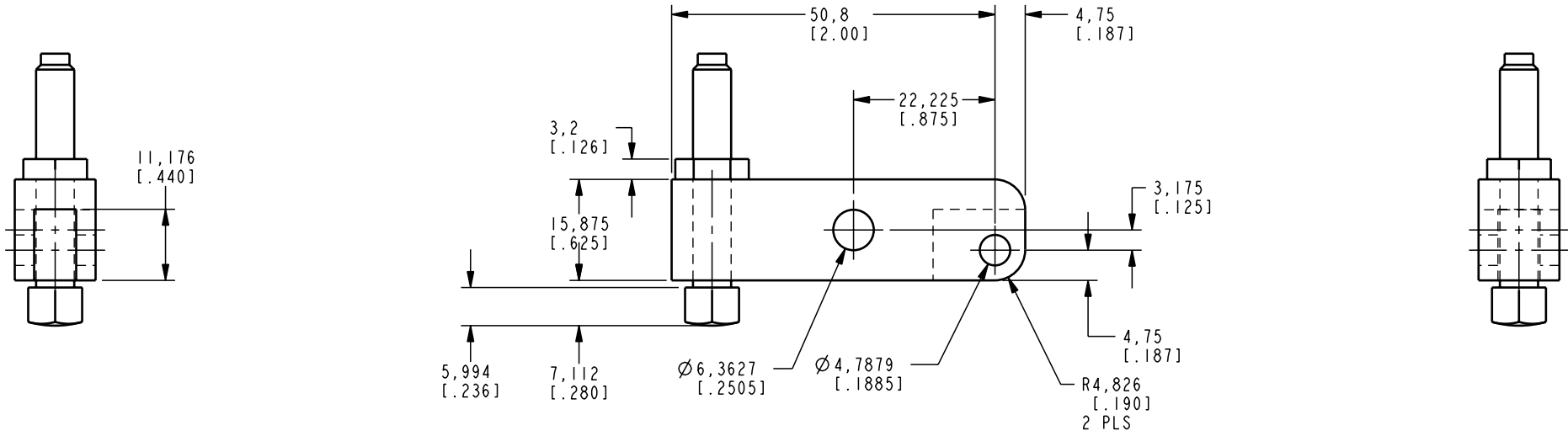

CAD CONTROL DRAWING			
		VEKTEK, INC. 1334 E. SIXTH AVE. P.O. BOX 625 EMPORIA, KS. 66801 U.S.A.	

B	1433	RELEASE	K. ROEMER	02-15-06	91600403	A	LEVER, LC, 2 KN	
REV	IN ACCORDANCE WITH ECN	EFFECTIVE DATE	REVISED BY	DATE	REFERENCE MODEL	REF REV	*****	
DRW BY:	K. ROEMER	DRAWING STATUS: Released			TOLERANCES DO NOT APPLY	UNITS	SIZE	
DATE:	10-17-05	PRODUCTION APPROVED FOR RELEASED STATUS ONLY			DIMENSIONS ARE NOMINAL	mm [inch]	B	
							ILCM91600403	REV B

FORM FEG036, Rev. A