

1

2

3

4

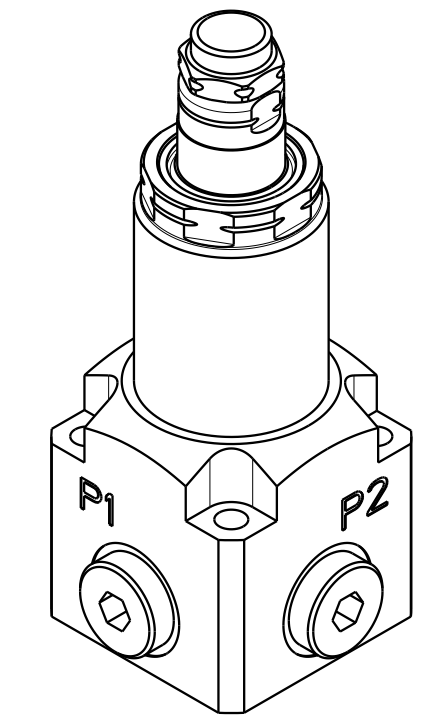
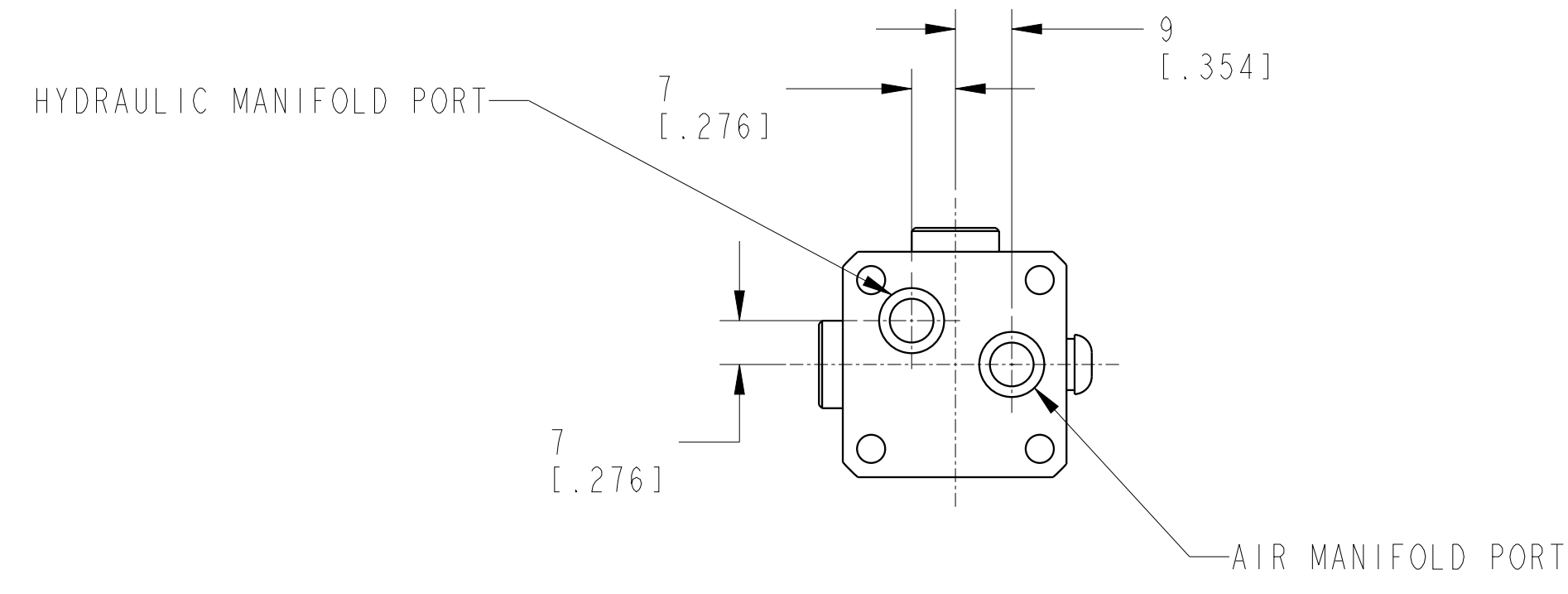

ILCMV41080626PS REV A ECN4540

SCALE 1

SEE IS5003 FOR PART PRESENT SENSOR SETUP

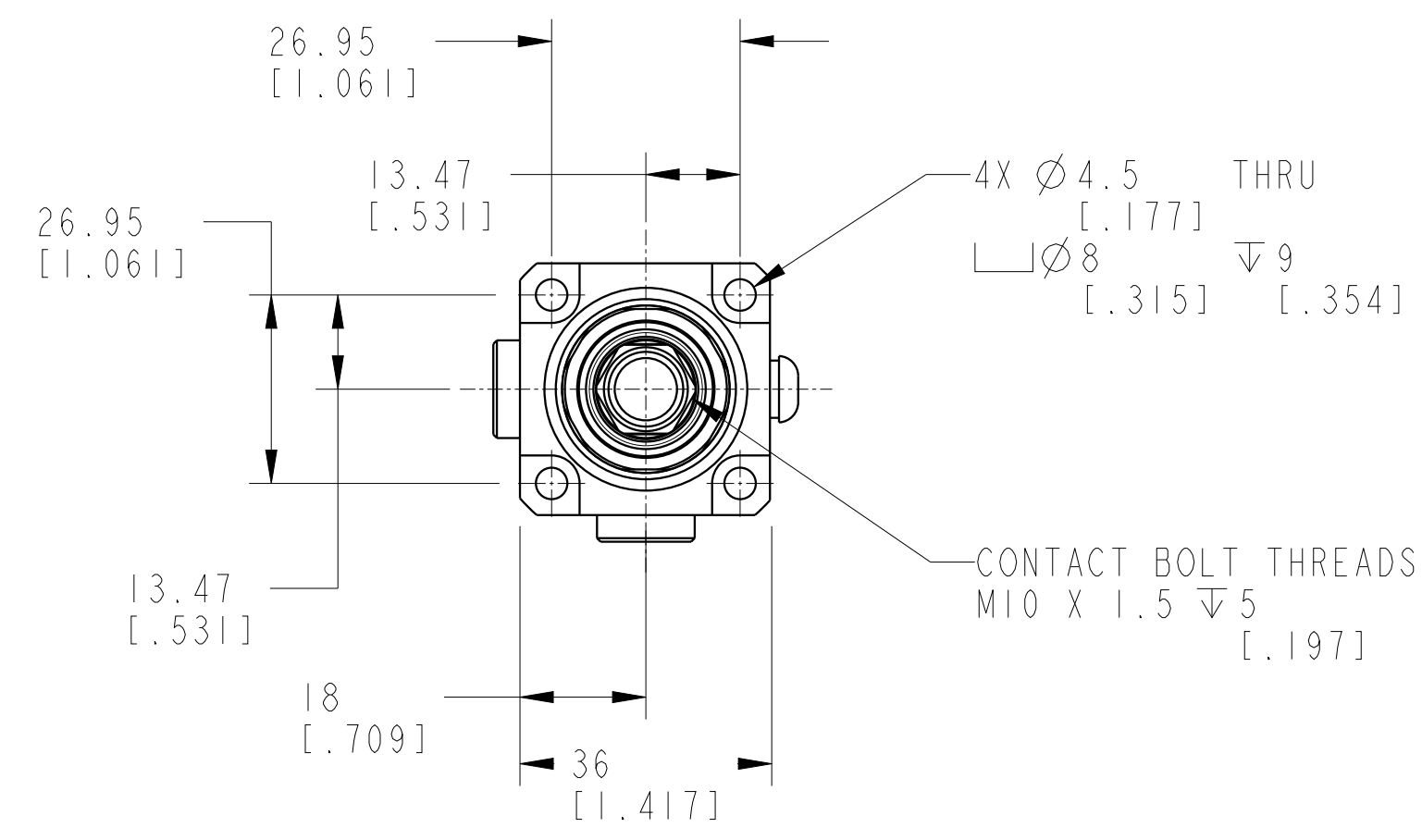
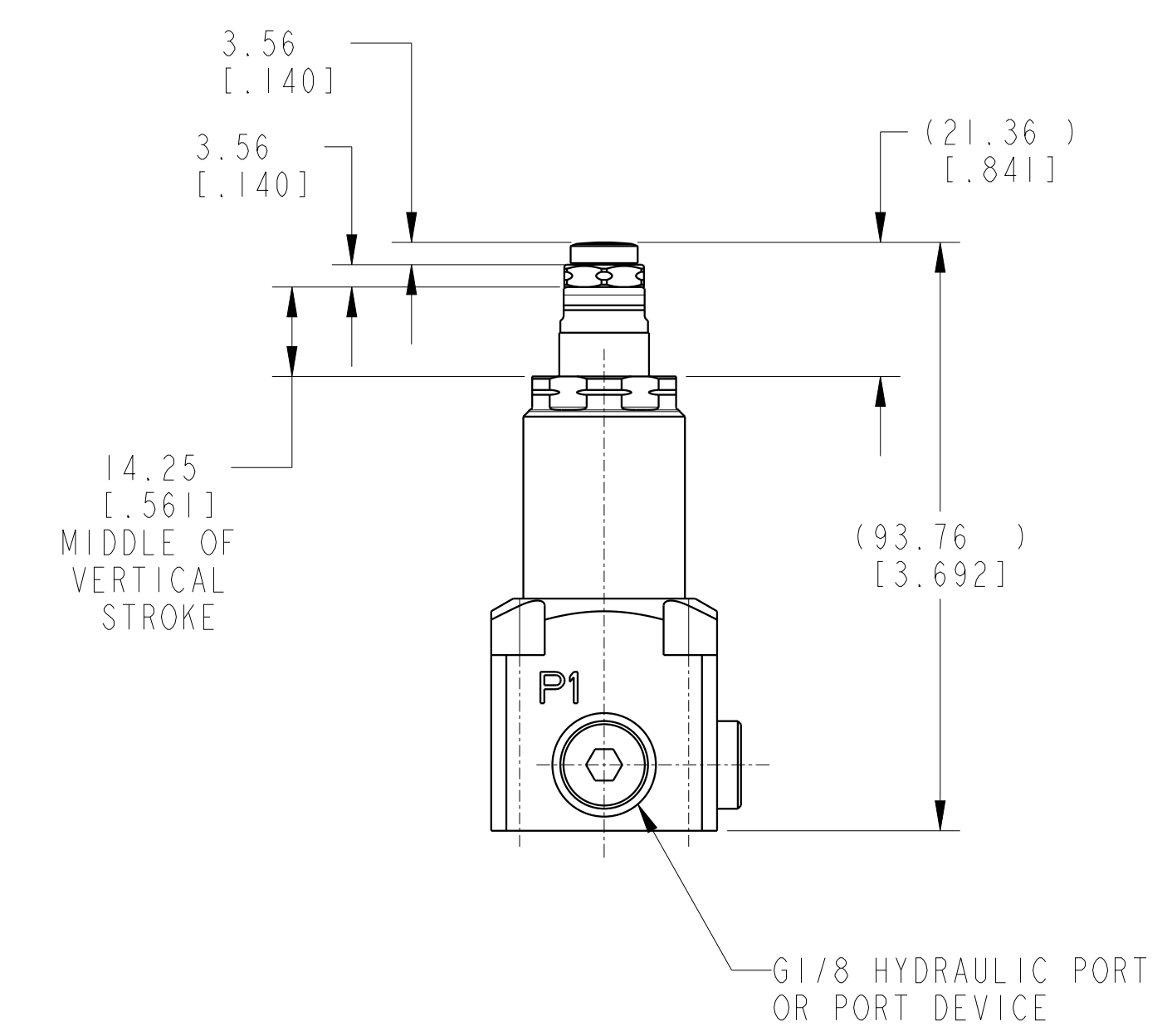
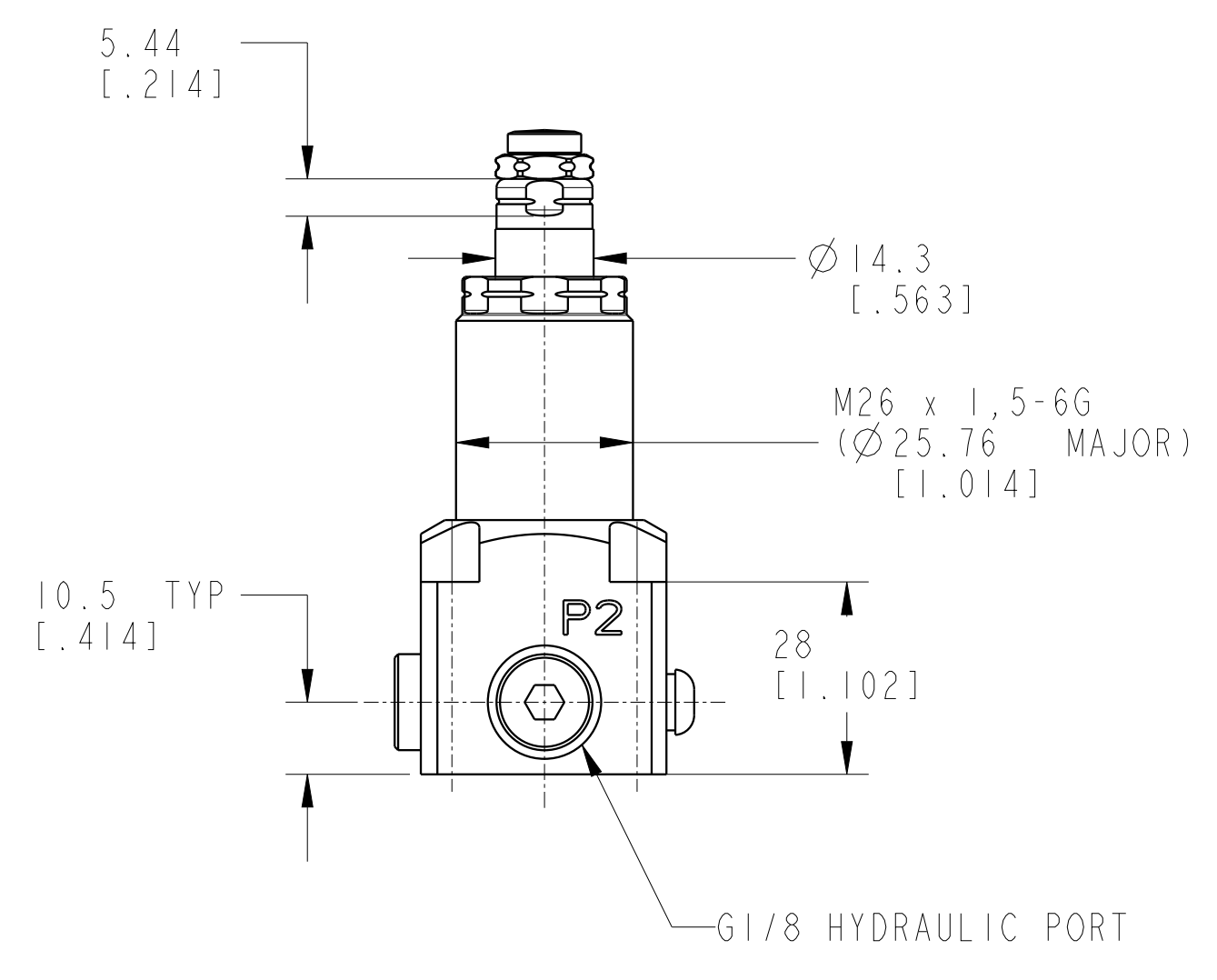
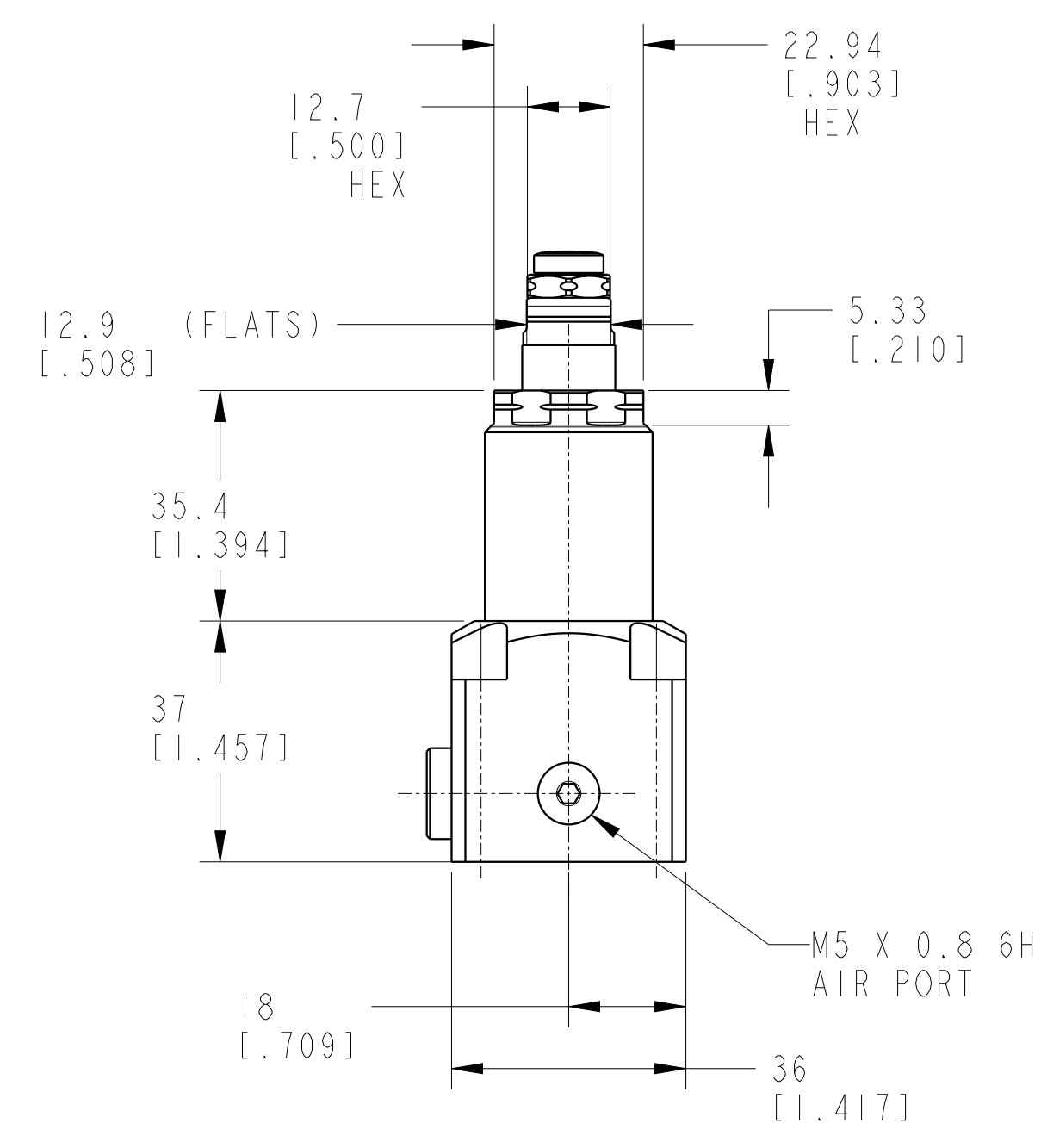

CAD CONTROL DRAWING

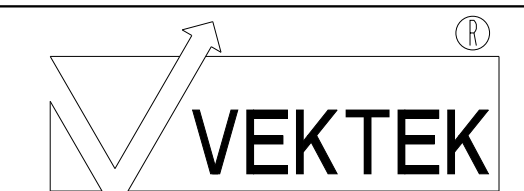

VEKTEK, INC.
1334 E. SIXTH AVE. P.O. BOX 625
EMPORIA, KS. 66801 U.S.A.

A	4540	RELEASE	ALS	3/28/22	41080626PS	A	WS, FA, BM, HC, 8.9kN, LS, PPS
REV	IN ACCORDANCE WITH ECN	EFFECTIVE DATE	REVISED BY	DATE	REFERENCE MODEL	REF REV	
DRW BY:	ALS	DRAWING STATUS: Released			TOLERANCES DO NOT APPLY	UNITS	SIZE
DATE:	05/30/19	PRODUCTION APPROVED FOR RELEASED STATUS ONLY			DIMENSIONS ARE NOMINAL	mm (inch)	D
					ILCMV41080626PS		REV A