

I L C M V A P 6 1 0 2 5 0 0 5 R E V A E C N 5 7 5 2

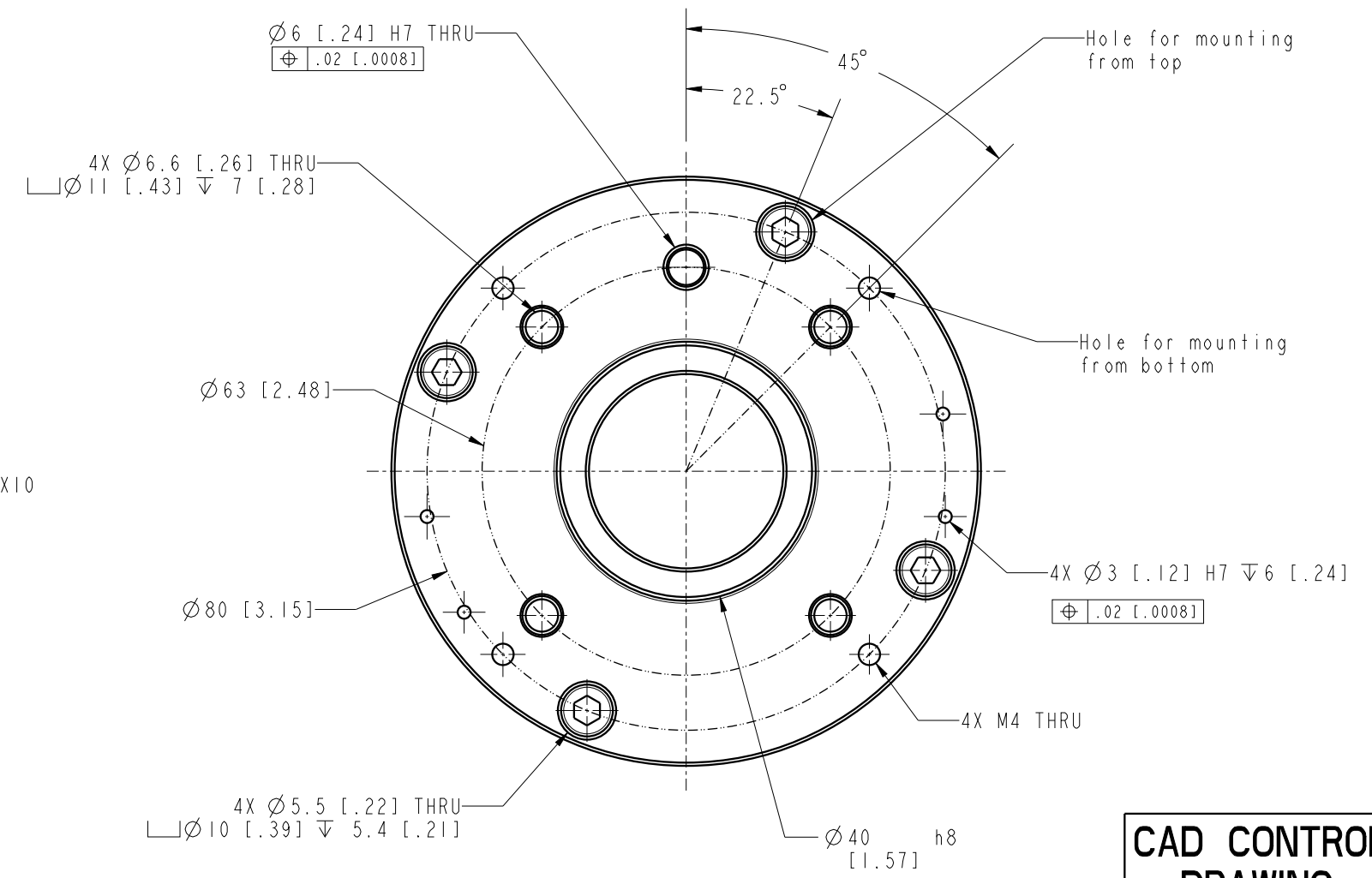
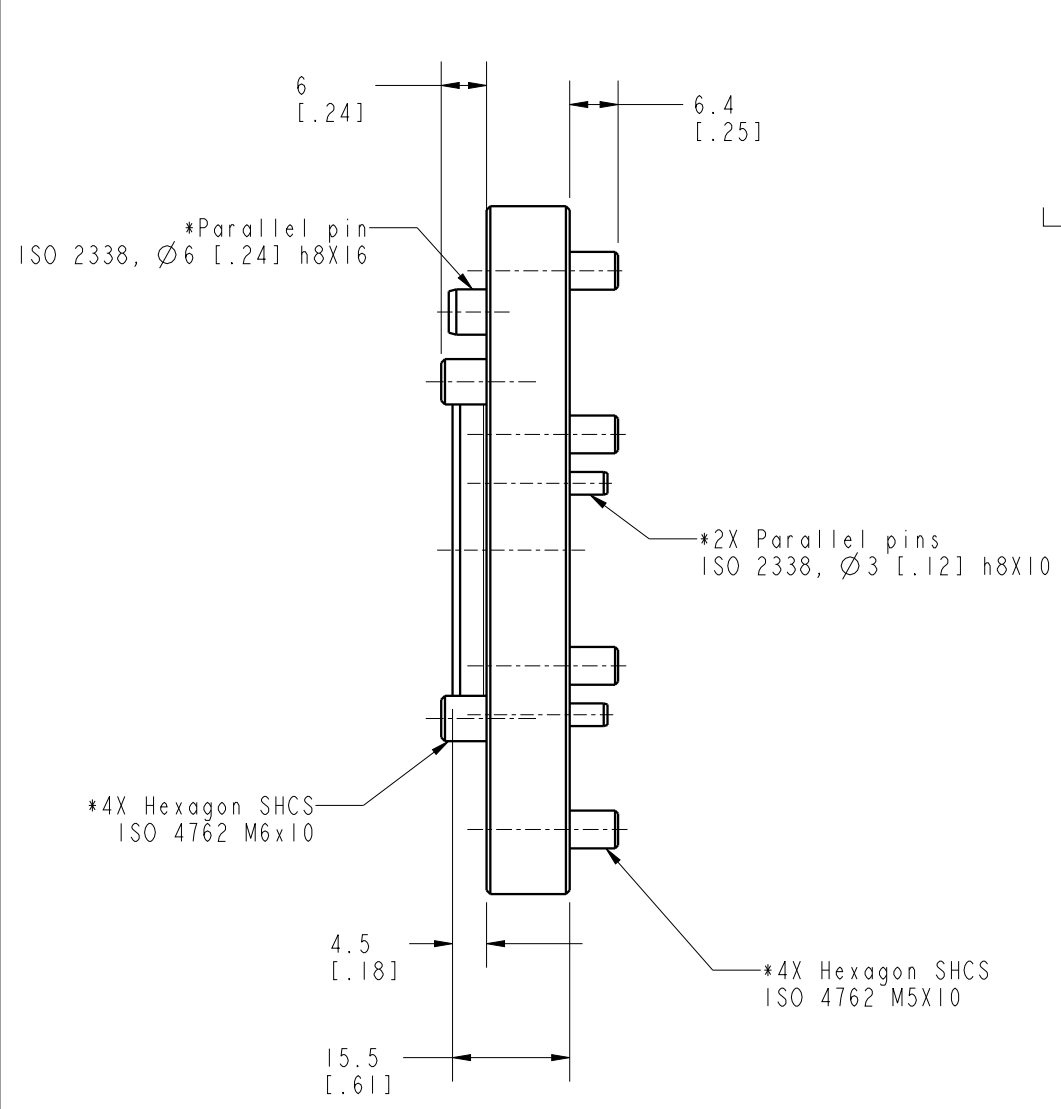

NOTES:
1. *Items are included

CAD CONTROL DRAWING			
		VEKTEK, INC. 1334 E. SIXTH AVE., P.O. BOX 625 EMPORIA, KS. 66801 U.S.A.	

A	5752	RELEASE	ALS	10/22/25	VAP61025005	A	IMPAQT, RC, PQ0, ISO-63	
REV	IN ACCORDANCE WITH ECN	EFFECTIVE DATE	REVISED BY	DATE	REFERENCE MODEL	REF REV		
DRW BY:	ALS	DRAWING STATUS: Released			TOLERANCES DO NOT APPLY	UNITS	SIZE	I L C M V A P 6 1 0 2 5 0 0 5 R E V A
DATE:	7/1/25	PRODUCTION APPROVED FOR RELEASED STATUS ONLY			DIMENSIONS ARE NOMINAL	mm [inch]	B	

FORM FEG036, Rev. C