

APPLY LUBRICANT TO ALL SEALS  
PRIOR TO INSTALLATION.  
DO NOT USE SILICONE TYPE LUBRICANTS.  
FOR PROPER ARM MOUNTING SEE IS1505.

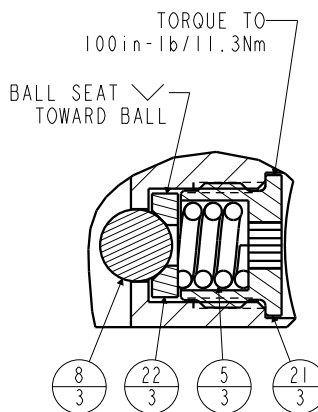

DETAIL A  
SCALE 1.500

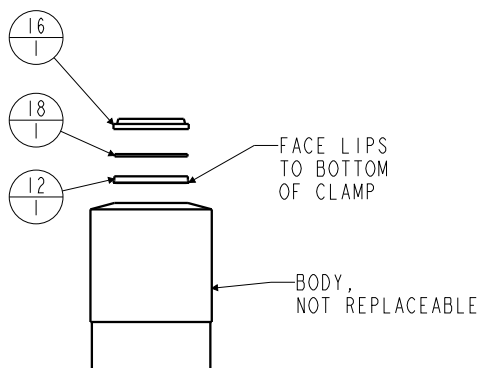
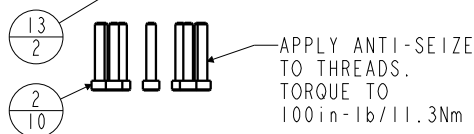
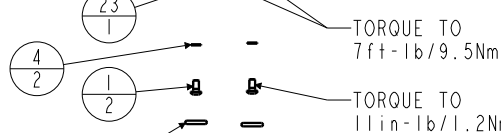
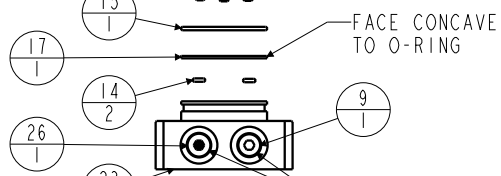
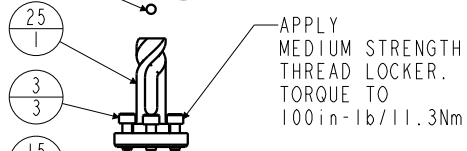
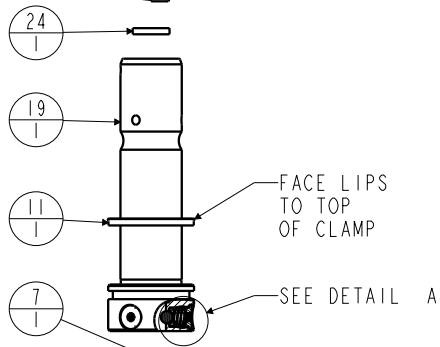
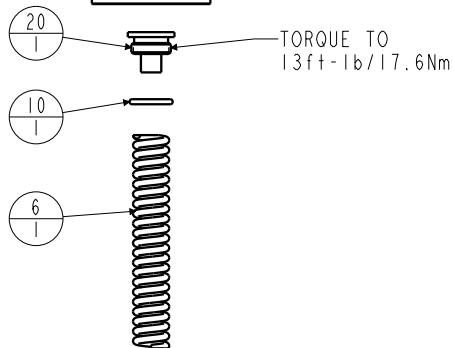

No.	QTY	PART No.	DESCRIPTION	Std. Seal Kit	FKM Seal Kit	Spring Kit
N/A	N/A	IS1505	INSTRUCTION SHEET, ARM INSTALLATION			
N/A	N/A	61704022	SPRING KIT			
N/A	N/A	6V711041	SEAL KIT, FKM			
N/A	N/A	60711041	SEAL KIT, STANDARD			
26	1	92090001	ASSY, BREATHER, SAE #4			
25	1	81591822	CAM, SC, LP, 5000/22KN, RH, TC			
24	1	81591302	DISK, 0.75 X .12			X
23	1	81541808	BASE, SC, BF, LP, 5000			
22	3	81532108	SEAT, BALL, SC, LP, TC			
21	3	81532107	RETAINER, SC, LP, TC			
20	1	81531811	PLUG, SC, LP, 5000&22KN, SA, TC			
19	1	81511810	PLUNGER, SC, LP, 5000&22KN, SA, TC			
18	1	39054008	BU RING, (-218)	X	X	
17	1	39054007	BU RING, (-030)	X	39054021	
16	1	39053005	WIPER, SNAP-IN, (-1/4)	X	X	
15	1	39051042	O-RING, (-030)	X	39V01021	
14	2	39051041	O-RING, (-006)	X	39V51041	
13	2	39050042	O-RING, (-011)	X	39051025	
12	1	39011060	SEAL, BEVEL W/HEEL INSERT, 1-1/4 x 1/8 x 1-1/2	X	39052015	
11	1	39011055	SEAL, BEVEL, 1-9/16 x 3/32 x 1-3/4	X	39052013	
10	1	39000029	O-RING, (-115)	X	39V00029	X
9	1	30601144	PLUG, SOCH, SAE 4			
8	3	23650004	BALL, TUNGSTEN-CARBIDE .250			
7	1	23600011	BALL, STEEL, ALLOY, .187			X
6	1	23350067	SPRING, COMPRESSION			X
5	3	23350066	SPRING, COMPRESSION			
4	2	21500200	WASHER			
3	3	21500031	SHCS, M5 x 0.8 x 14, ALY			
2	10	21500023	SHCS, M5 x .8-6G x 30MM			
1	2	21500019	SCREW, CAP, BTNH, M3 X 6, ALY			

## PARTS LIST



VEKTEK, INC.  
1334 E. SIXTH AVE. P.O. BOX 625  
EMPORIA, KS. 66801 U.S.A.

ASSEMBLIES AFFECTED  
14271800  
14271800F

PARTS LIST, ASSY, SC, LP, TC, BF, 5000, SA, RH

SIZE  
A PL7161

REV  
C

SHEET 1 OF 1

FORM FEG035\_PL\_ASIZE, REV. B

C	5922	RELEASE	JDW	03/18/26
REV	IN ACCORDANCE WITH ECN	EFFECTIVE DATE	REVISED BY	DATE
DRW BY:	JDW	DRAWING STATUS: <b>Released</b>		
DATE:	6-17-11	PRODUCTION APPROVED FOR RELEASED STATUS ONLY		

